

BI 121 Lecture 3



...Anatomy & Physiology Lab Thurs! Fun again!

I. Announcements AEC Notes? aec.uoregon.edu/peer-notetaking

II. Connections Q re: Homeostatic Model for BP? Active work!

III. Cell Anatomy, Physiology & Compartmentalization LS ch 2

A. How big? What boundaries? Why compartments? pp19-21

B. Basic survival skills ch 1 p 3

C. Organelles ≡ Intracellular specialty shops w/membranes

1. Endoplasmic Reticulum (ER) 2. Golgi 3. Lysosomes

4. Peroxisomes & 5. Mitochondria. LS 2012 pp 20-34

fig 2-1, 2-2, 2-3, 2-4, 2-5, 2-6, 2-7, 2-8 pp 20-7 tab 2-1 p 36

D. What about vaults? LS 2006, p 32

E. Physiol News Moms eggs execute Dad's mitochondria?

IV. Anaerobic vs Aerobic Metabolism Overview Many sources!

Mathews & Fox 1976...LS 2012 pp 26-33, fig 2-15 p 33

V. Introduction to Genetics LS 2012 ch 2 p 20-1 + Appendix C

A. What's a gene? Where? p A-18, fig C-2, C-3

B. Why are genes important? p A-18

C. What's DNA & what does it look like? pp A-18 thru A-20

D. How does information flow in the cell? fig C-6

E. How does DNA differ from RNA? pp A-20 thru A-22

F. Genetic code? pp A-22, A-23

G. How are proteins made? fig C-7, C-9

Blood Pressure Homeostasis

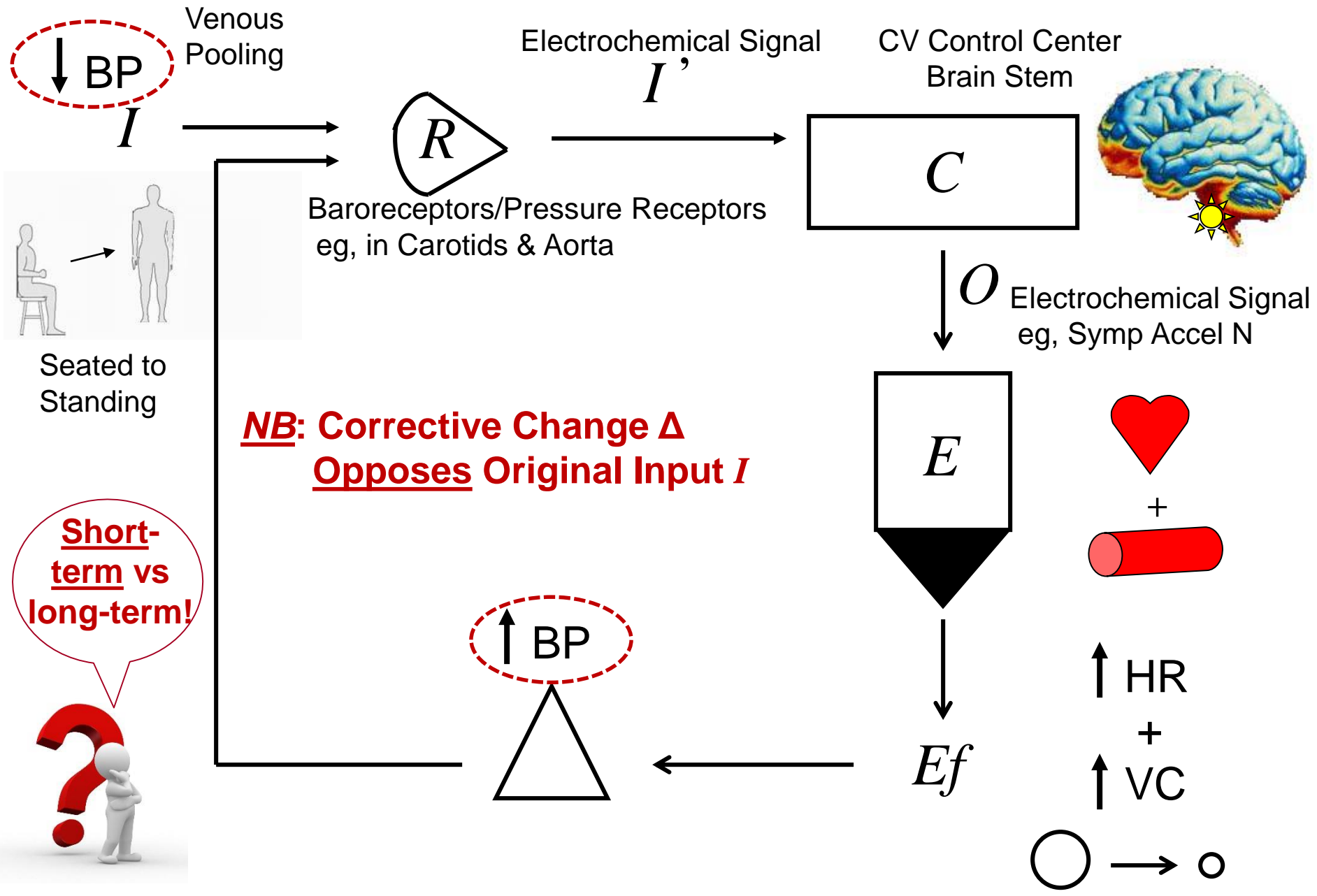

Active Learning Group Work



How Big? 100 Cells Lengthwise = 1 mm!!

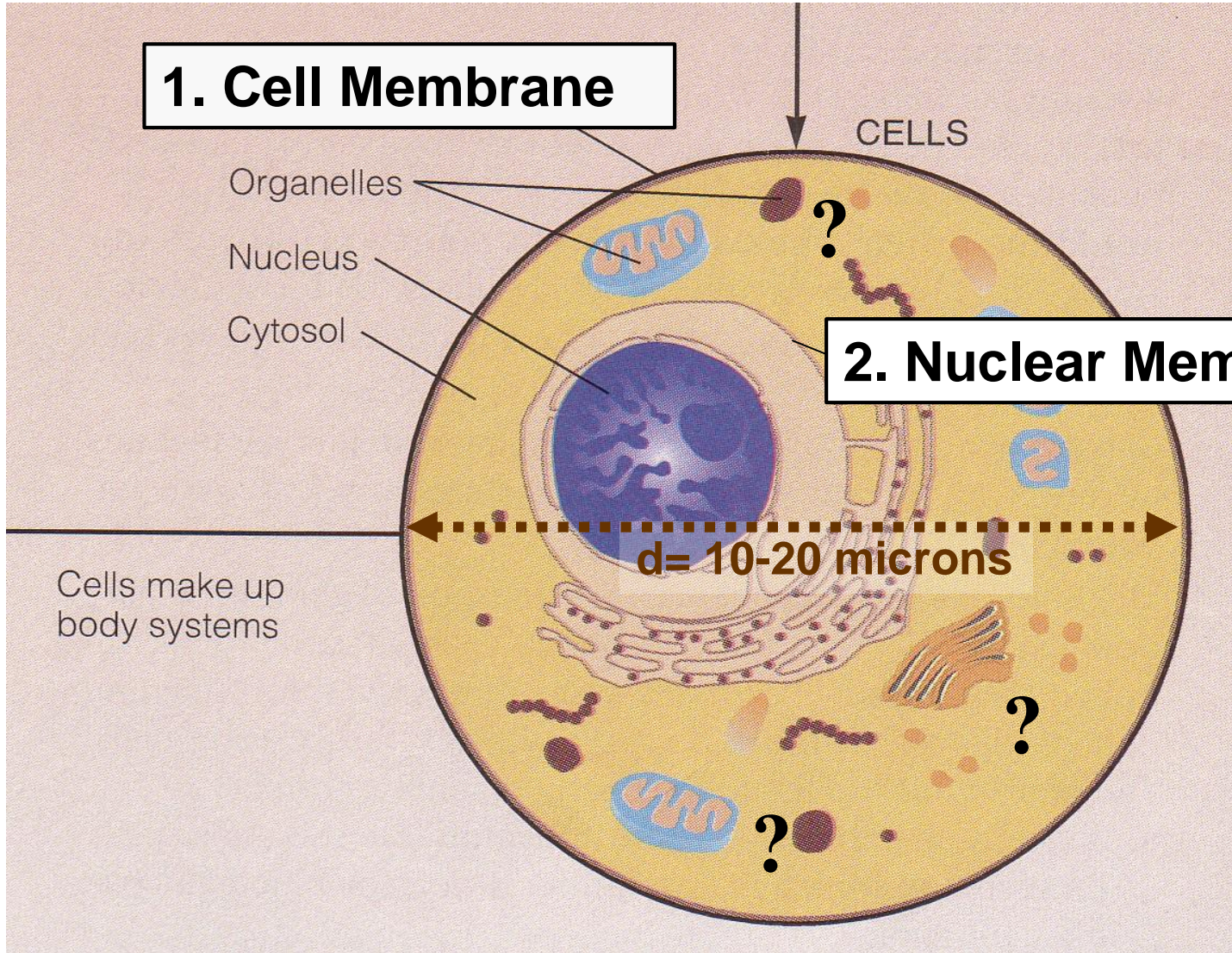

<http://opb.pbslearningmedia.org/resource/tdc02.sci.life.cell.nucleus/nucleus-cytoplasm-membrane/>

Cytoplasm = Cell - Nucleus

[Extract nucleus; includes organelles]

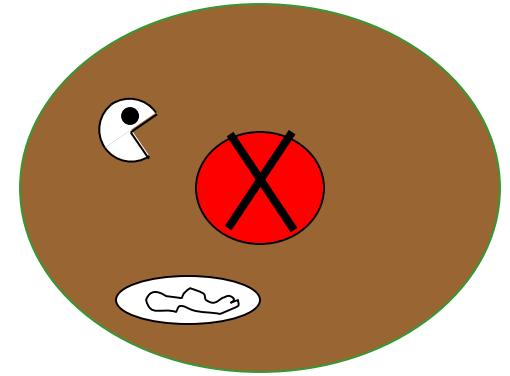

Cytosol = Cytoplasm - Organelles

[Extract organelles; complex gel-liquid]

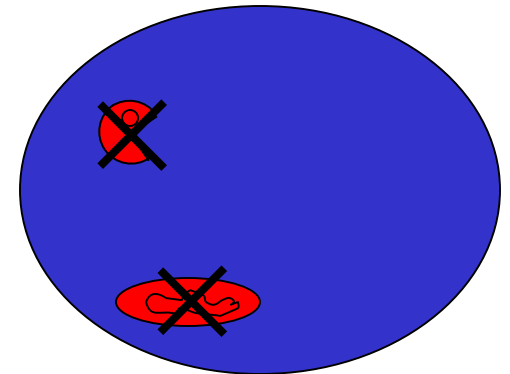

Why Compartments? Advantage?

**Incompatible reactions can
take place**

Simultaneously!!

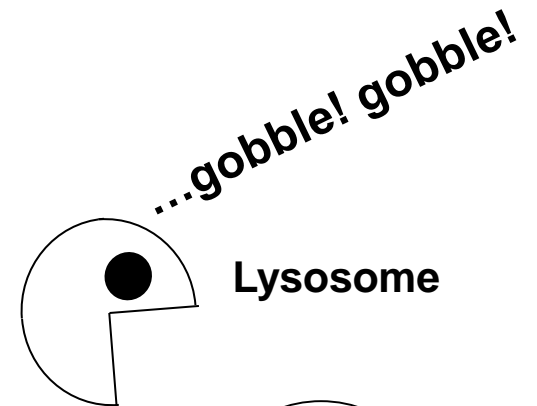

Lysosome

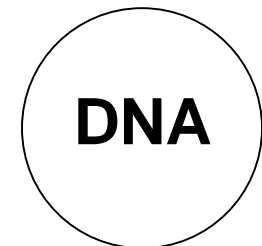

Nucleus

Basic Cell Survival Skills?

- 1. Get food**
- 2. Use food**
- 3. Rid wastes**
- 4. Move**
- 5. Reproduce**

Nucleus or nose?

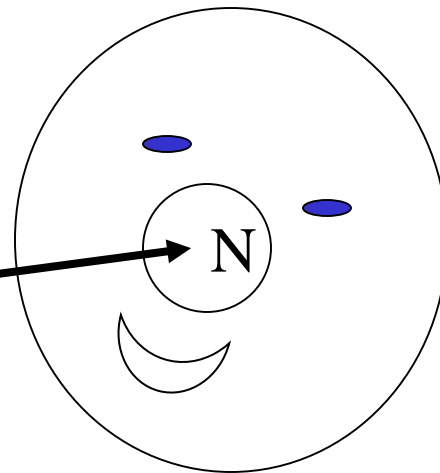

How to live?

1 Sample Cartoon of 100 Trillion (100×10^{12}) Cells!

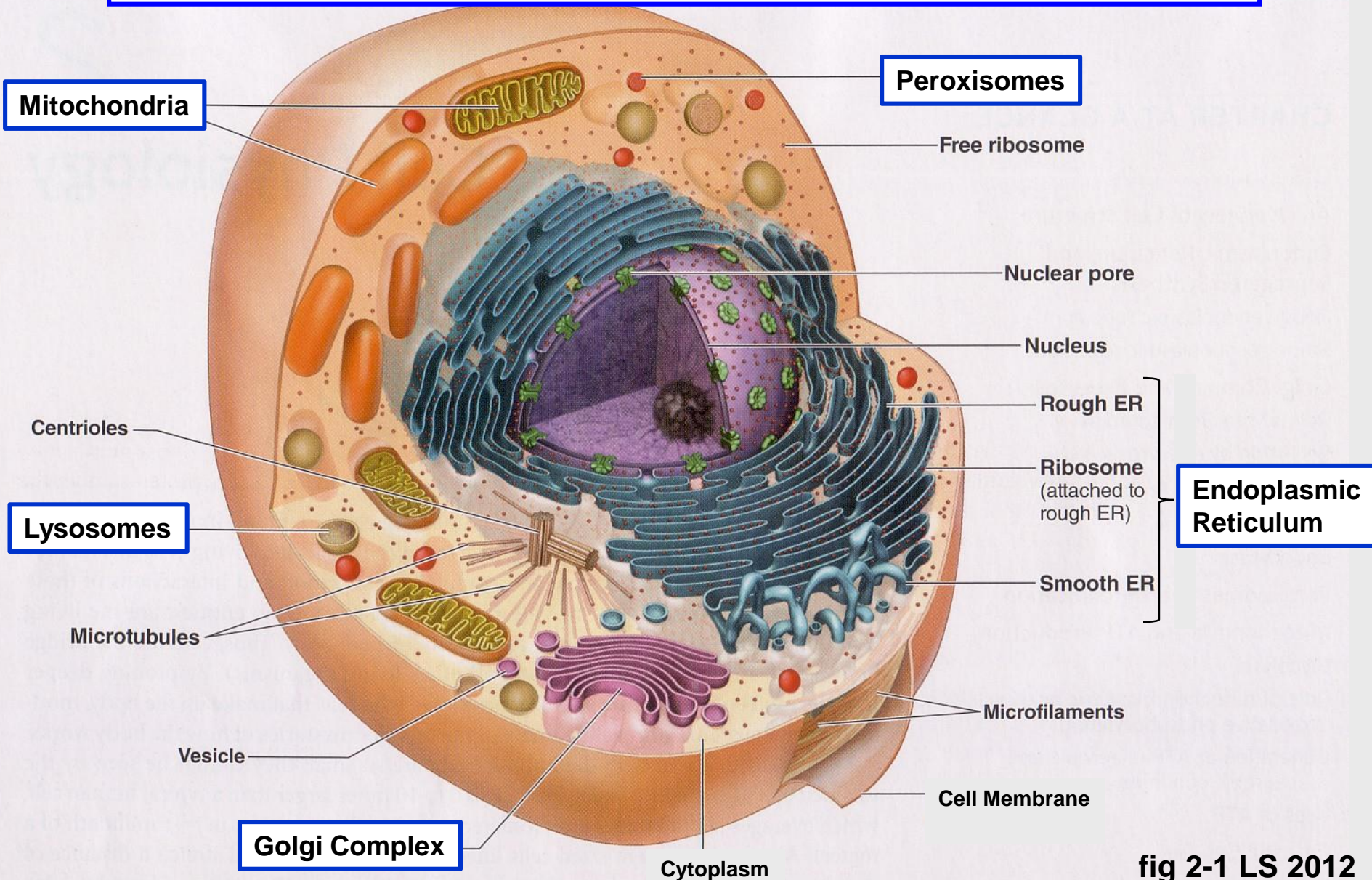
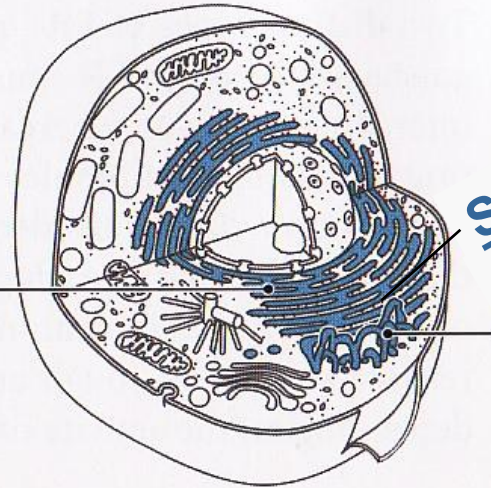

fig 2-1 LS 2012

<http://opb.pbslearningmedia.org/resource/tdc02.sci.life.cell.organelles/organelles-in-the-cytoplasm/>

Rough & Smooth Endoplasmic Reticulum (ER): Protein & Lipid Synthesizing Factories



Smooth ER:
1. packages new proteins in transport vesicles
2. stores calcium in muscles

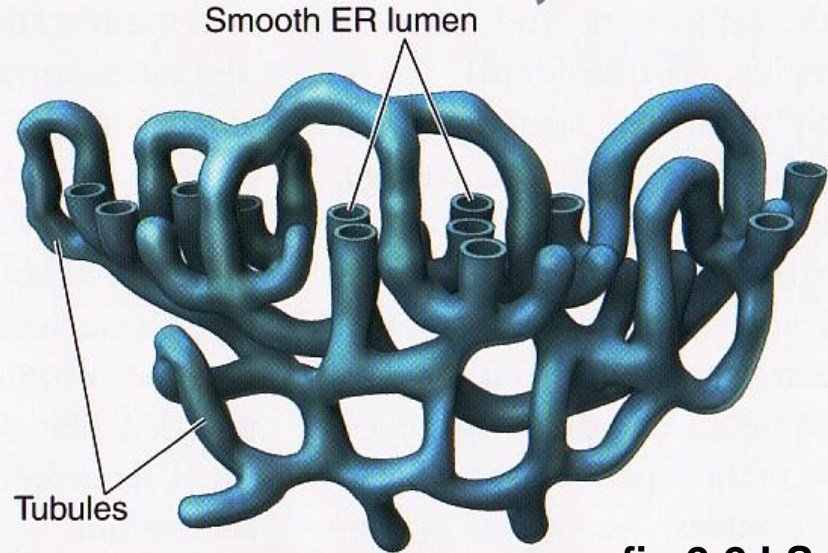
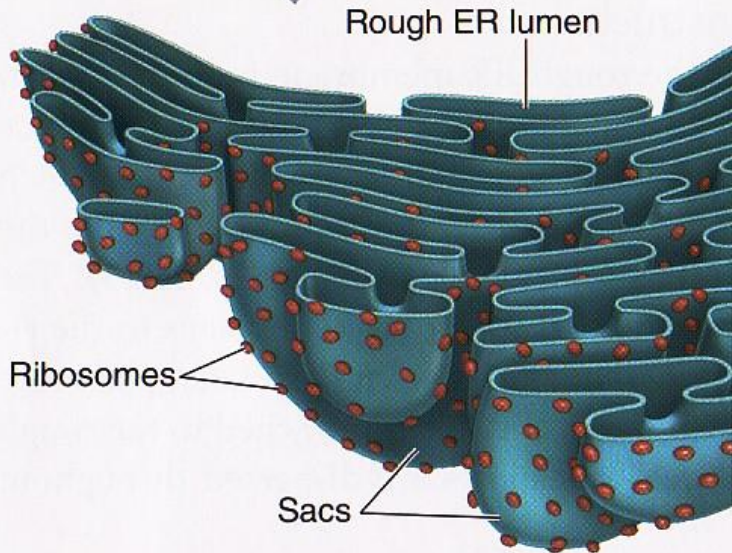
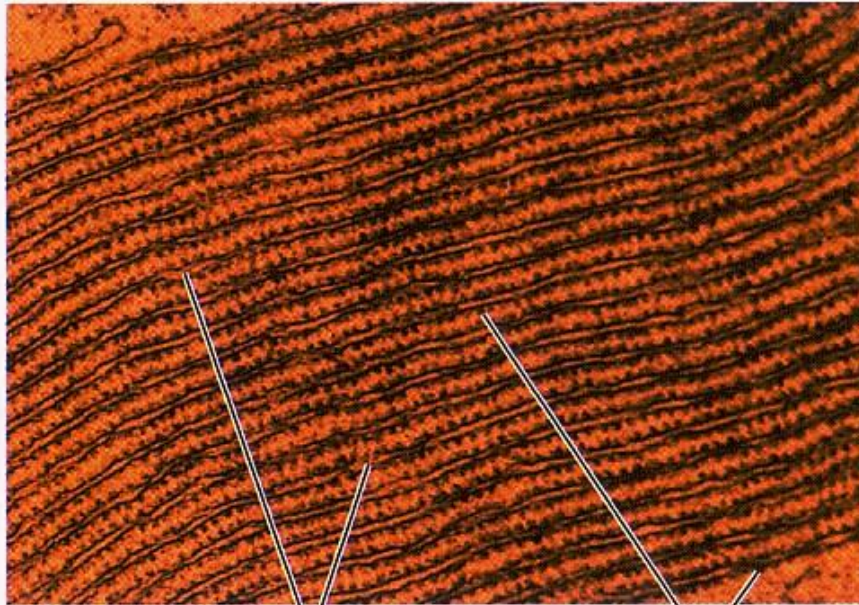

fig 2-2 LS 2012

Electron Micrographs of Rough vs. Smooth ER



Rough ER lumen

Ribosomes

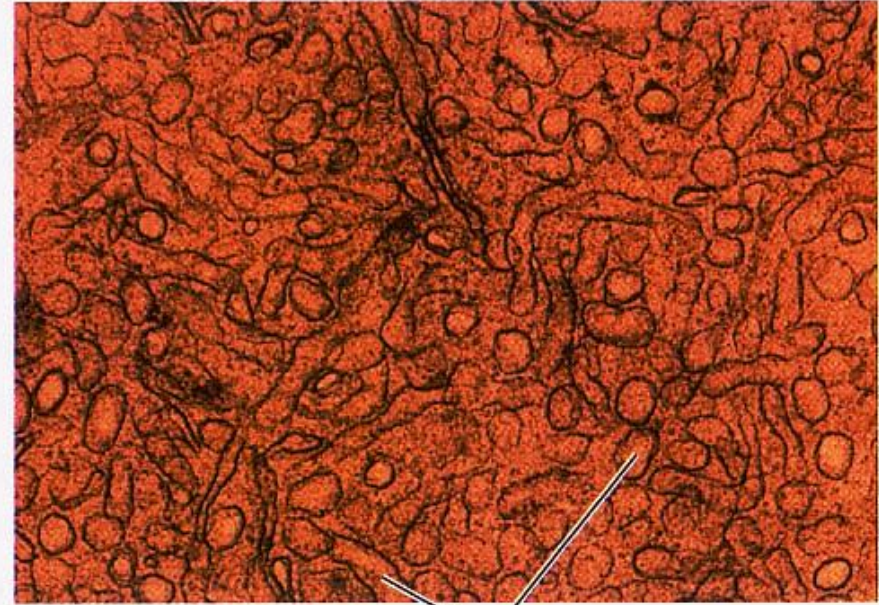

Smooth ER lumen

© Don W. Fawcett/Visuals Unlimited

Secretion of Proteins Produced by ER

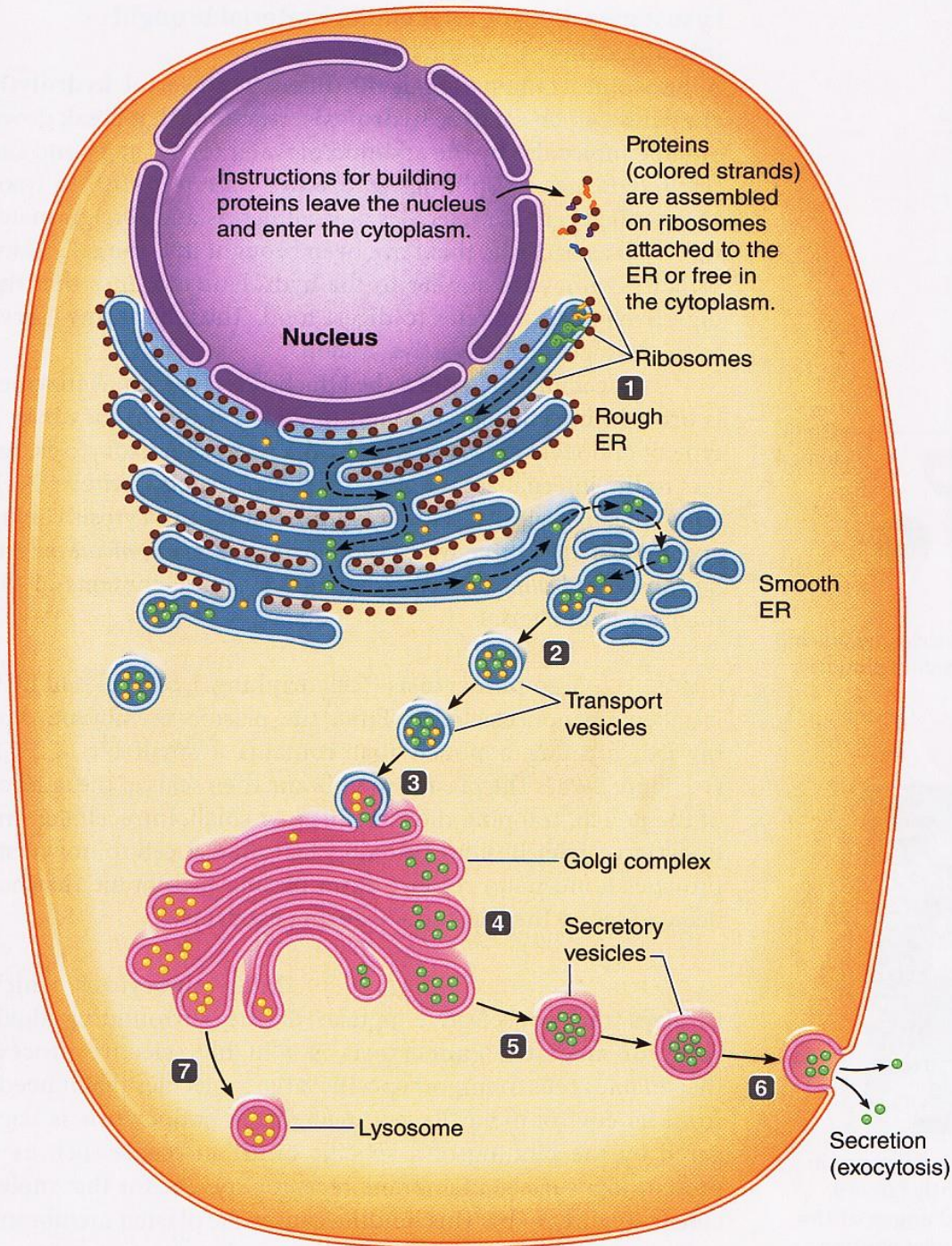
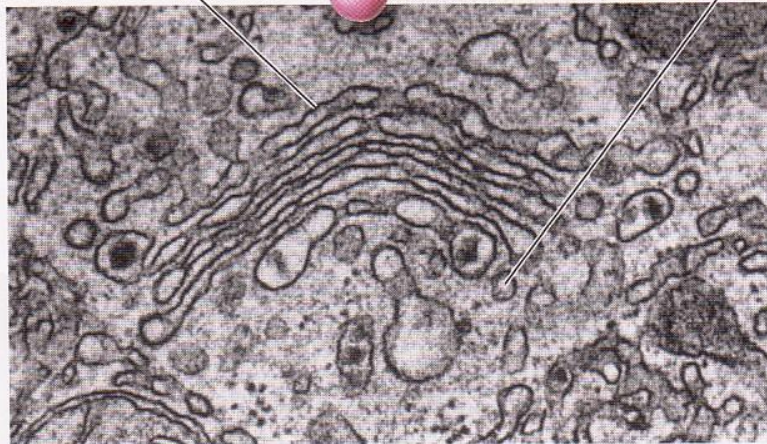
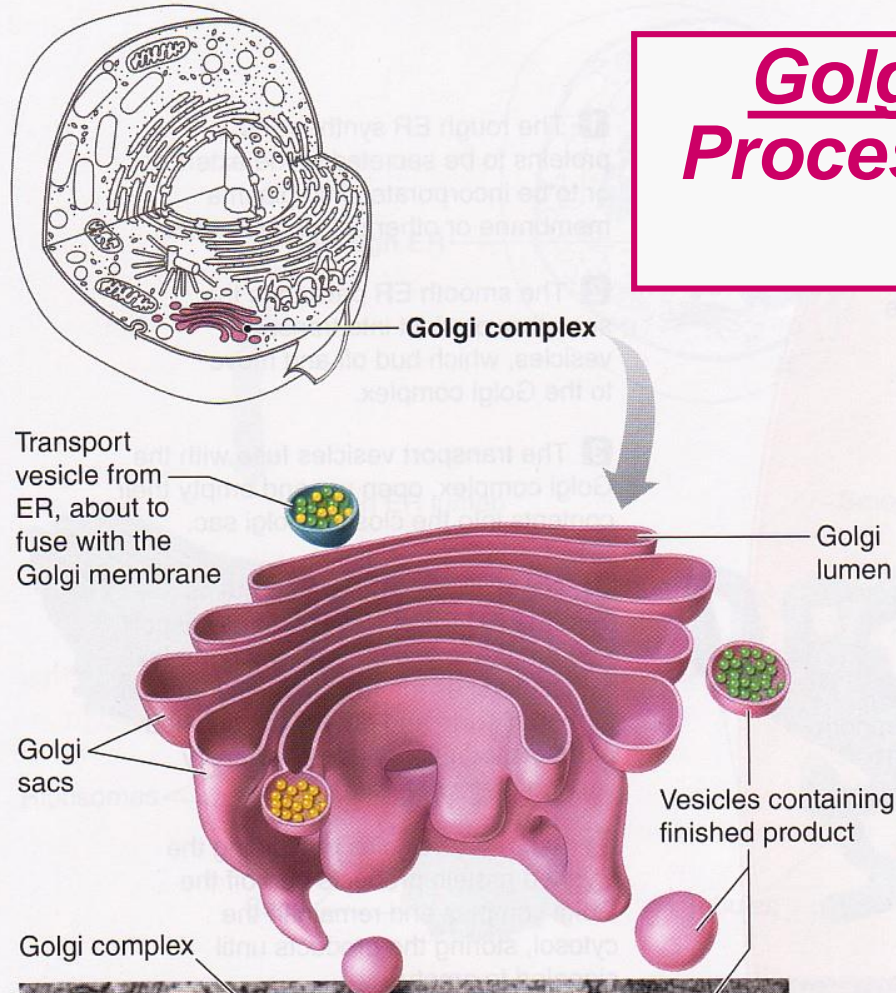

fig 2-3 LS 2012

Golgi Complex: Final Processing, Packaging & Distribution



Dr. Don Fawcett & R. Bollender/Visuals Unlimited

fig 2-4 LS 2012

Exocytosis: Primary Means of Secretion

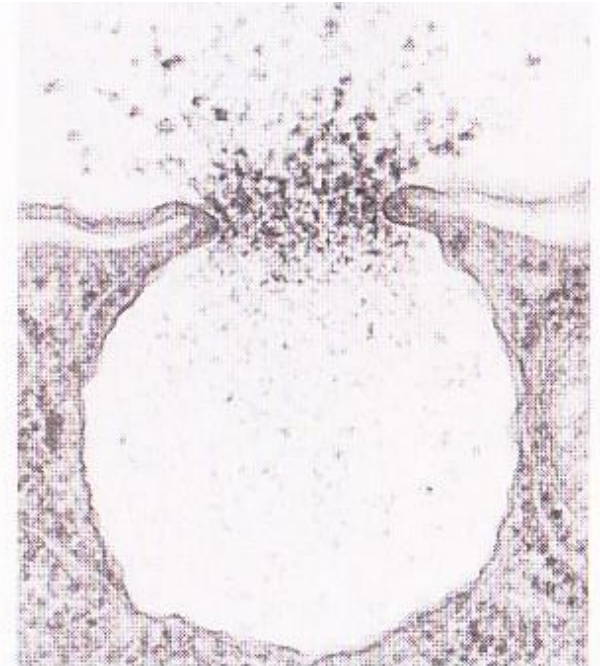
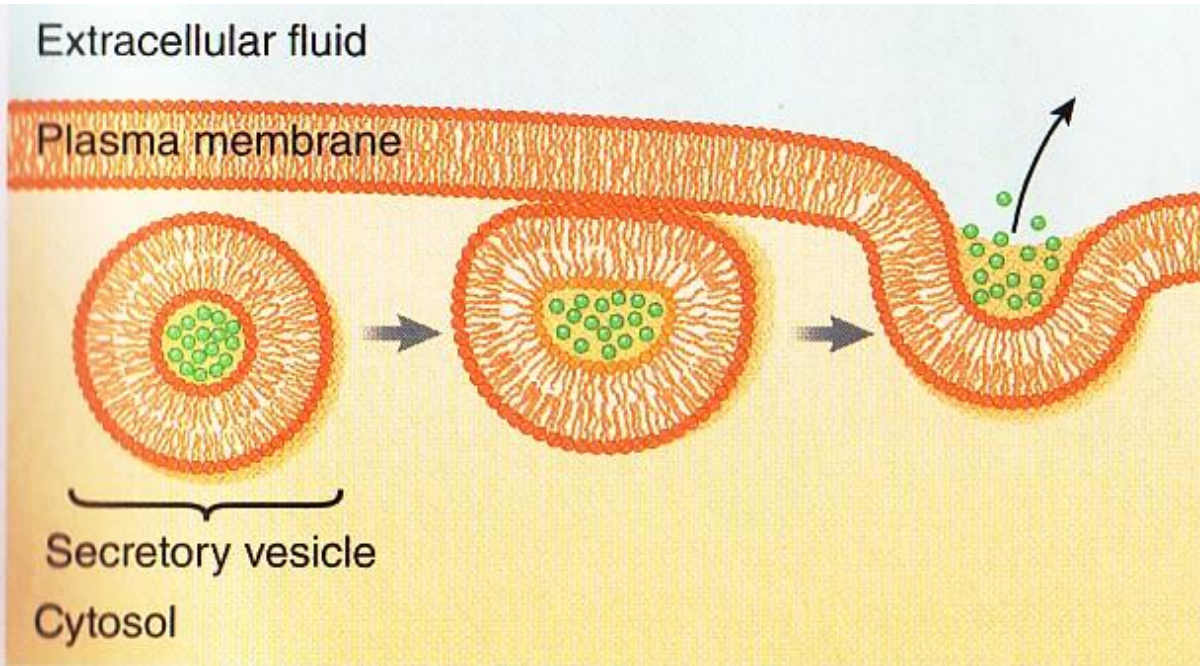

Endocytosis: Primary Means of Ingestion

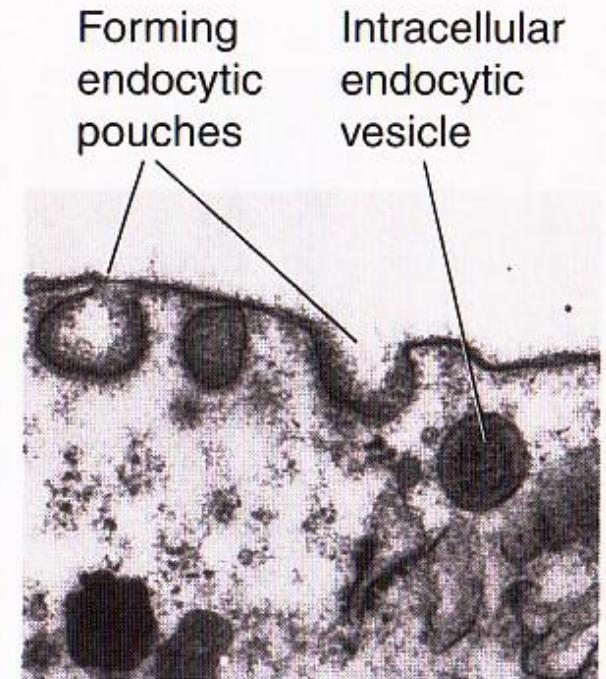
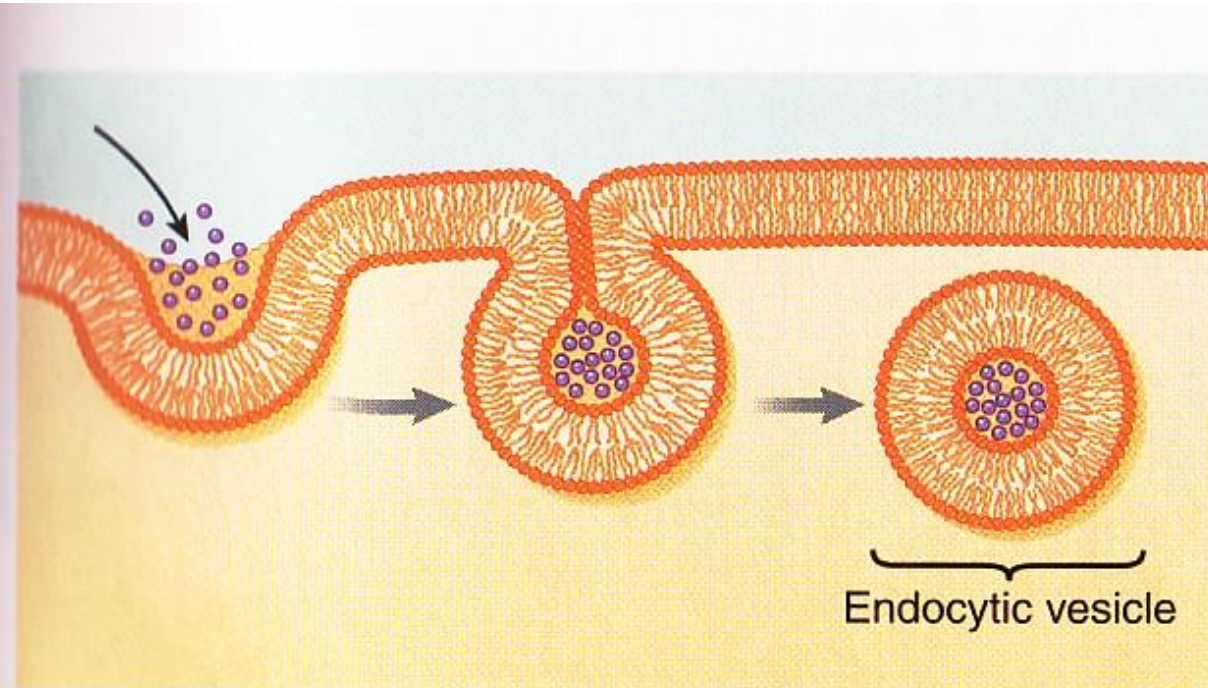

(b) © Don W. Fawcett/Photo Researchers, Inc.

Lysosomes vs. Peroxisomes

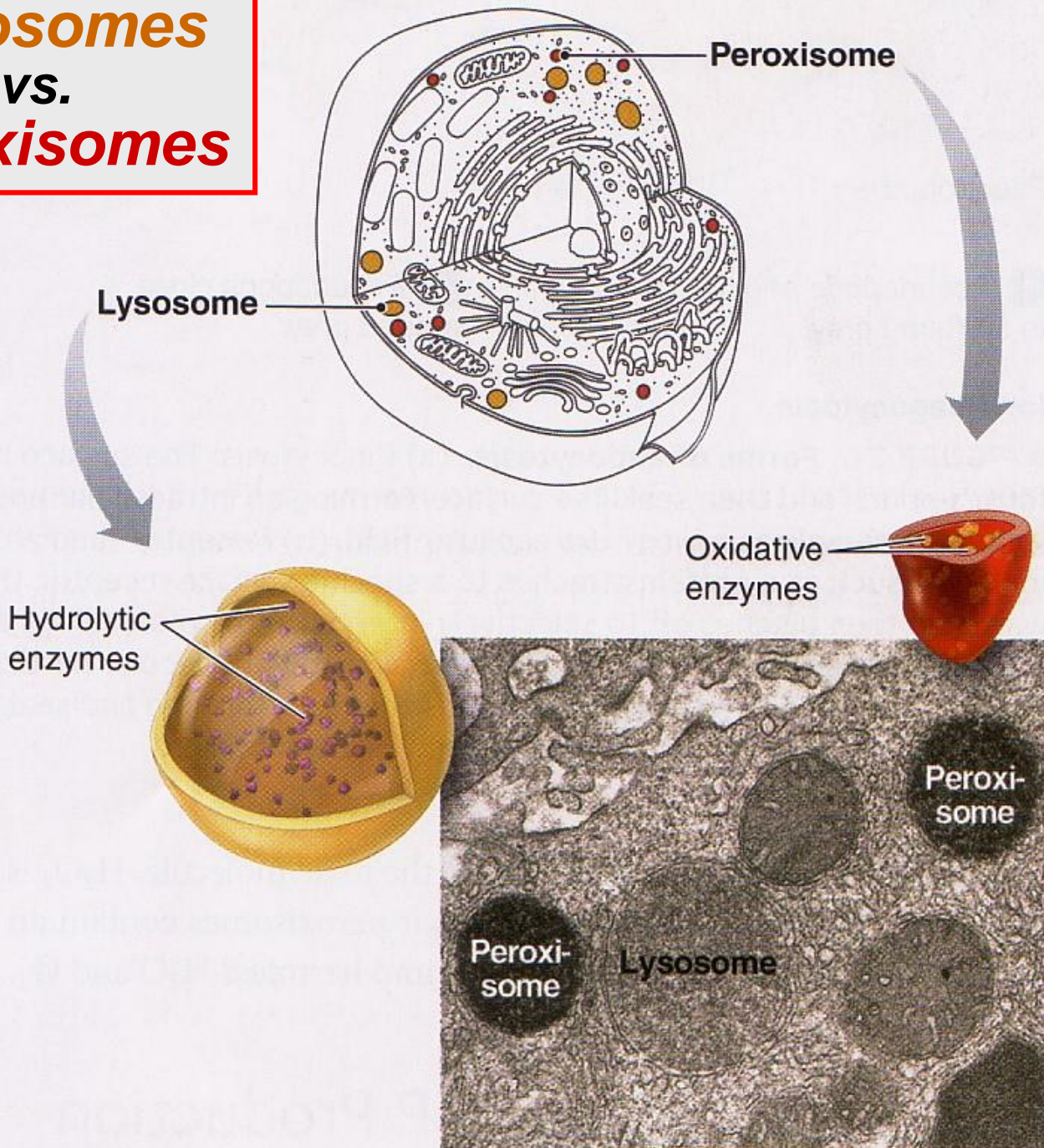

© Don W. Fawcett/Photo Researchers, Inc.

fig 2-6 LS 2012

Phagocytosis: Cell Eating!

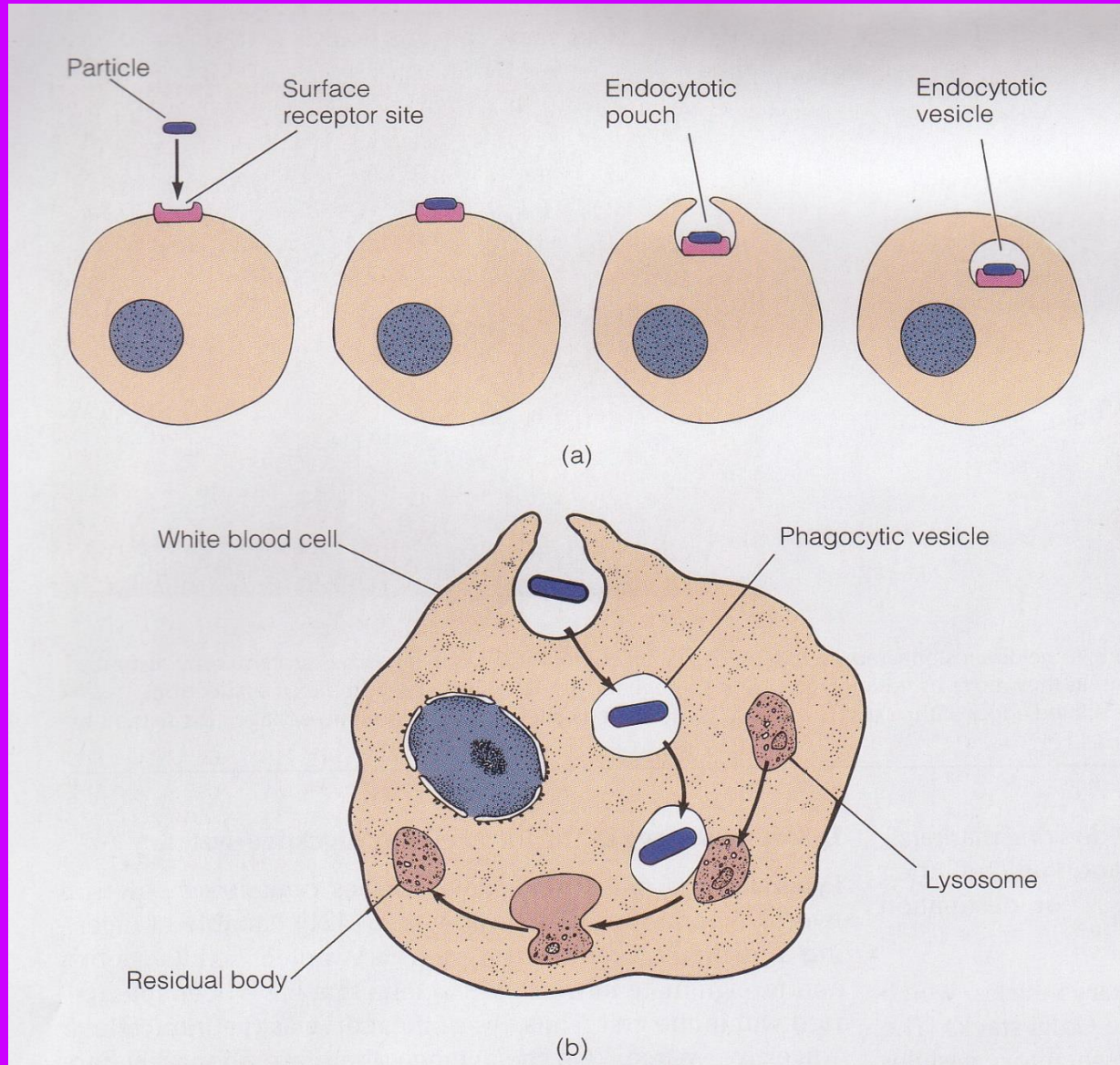



Film: Neutrophil engulfing bacterium

<http://devreotes.johnshopkins.edu/videos>

Catalase Enzyme Reaction in Peroxisomes Neutralize Toxin at Production Site!

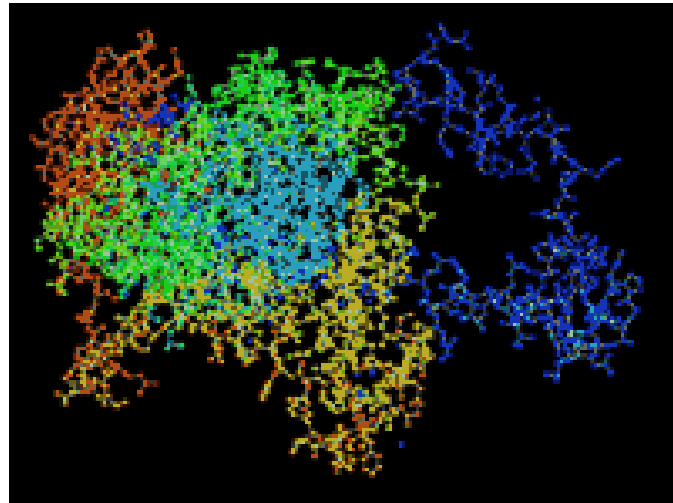

Mitochondria: Energy Organelles

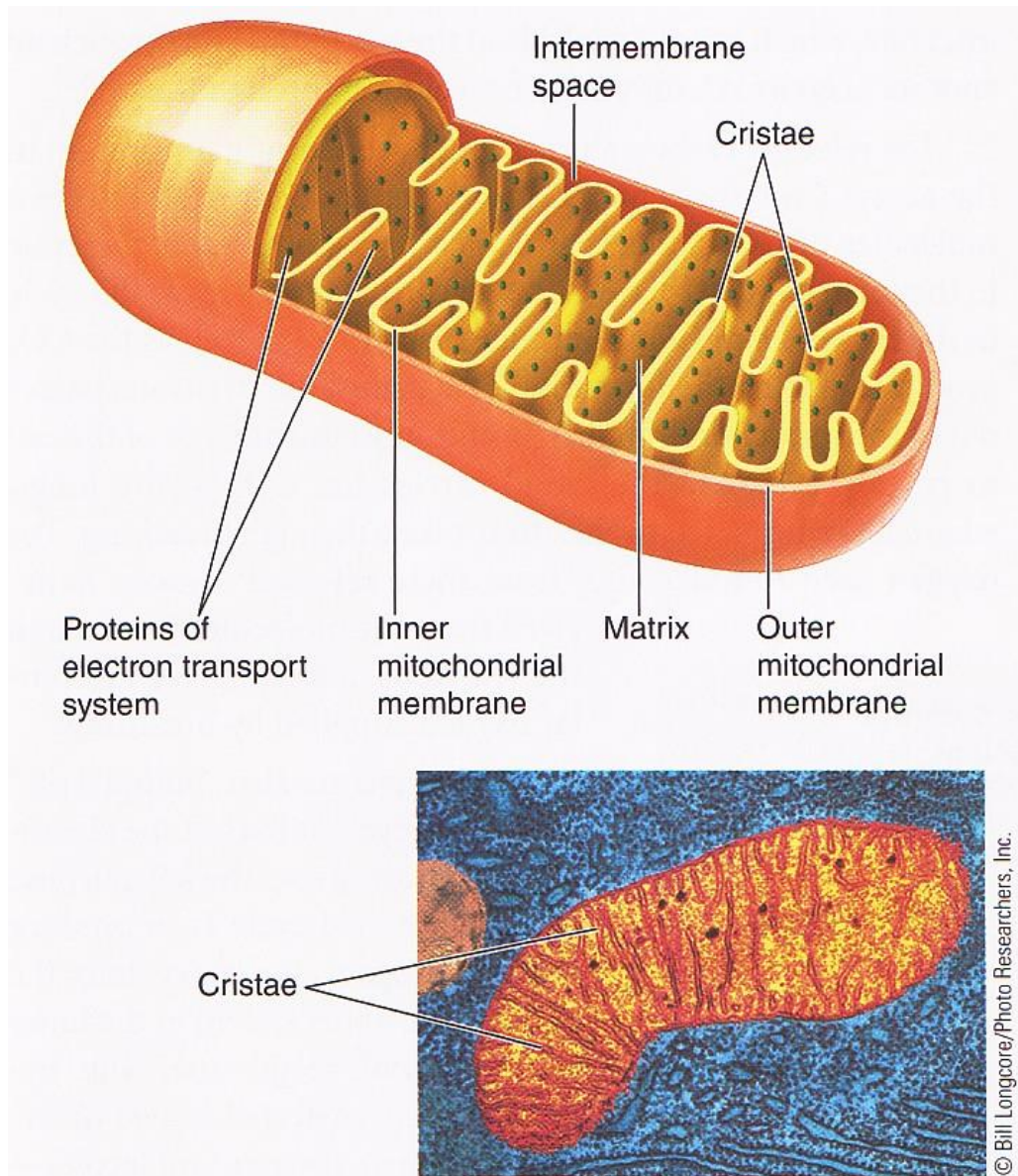
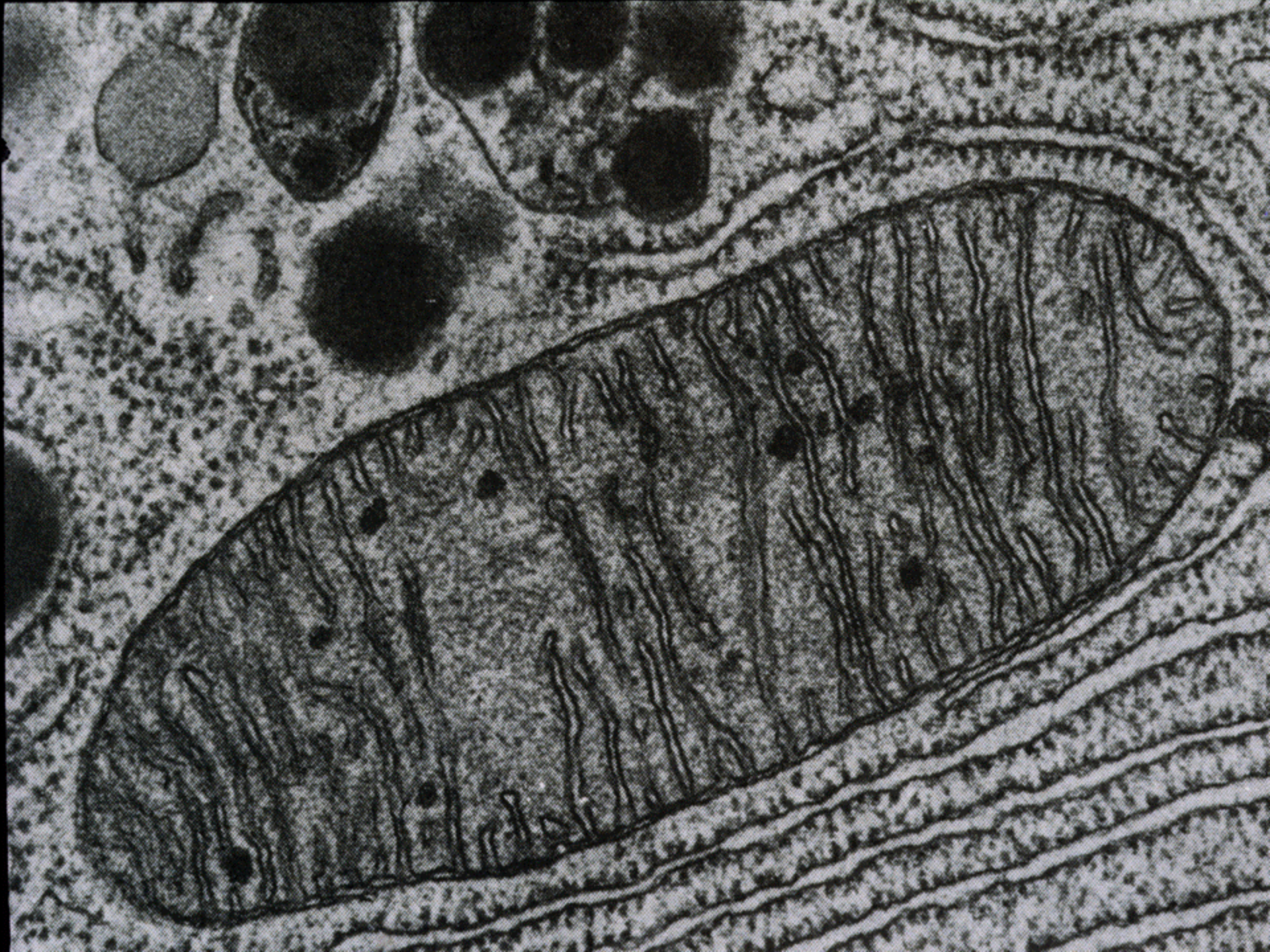
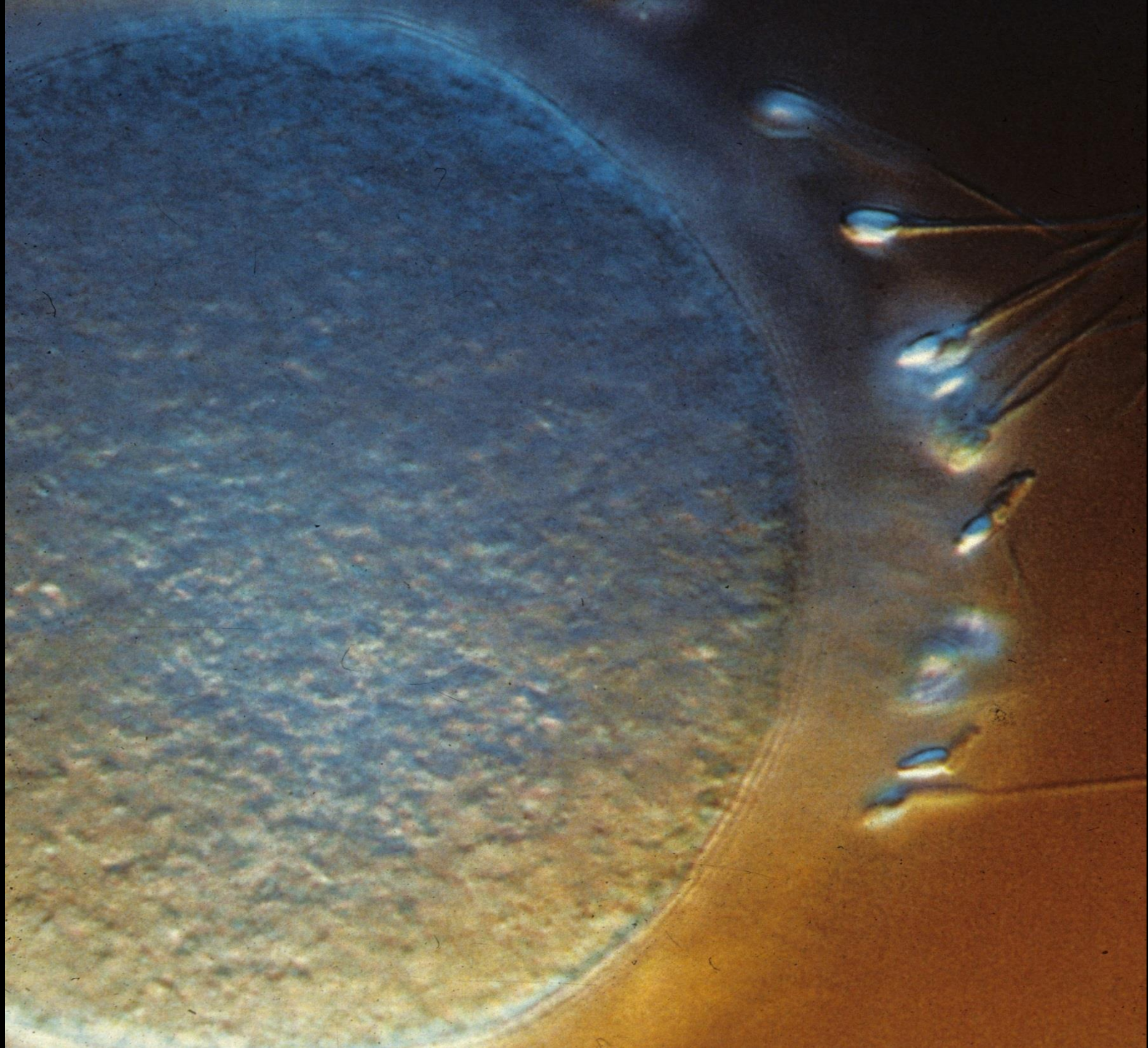

fig 2-8 LS 2012





Mom's eggs execute Dad's mitochondria

In "Hamlet," Rosencrantz and Guildenstern deliver a letter to the rulers of England that carries the ill-fated duo's own death sentence. Perhaps Shakespeare knew a bit about reproductive biology.

Scientists have now found that during a sperm's creation, its mitochondria—energy-producing units that power all cells—acquire molecular tags that mark them for destruction once the sperm fertilizes an egg. This death sentence, a protein called ubiquitin, may explain why mammals inherit the DNA within mitochondria only from their mothers, a bio-

species mitochondrial inheritance. Sperm mitochondria sometimes avoid destruction when two different species of mice mate, and Schatten's team has shown this also holds true in cattle. It's hard to understand how an egg distinguishes between paternal mitochondria of closely related species, says Schon.

When paternal mitochondria escape destruction in normal mating, the resulting embryo may suffer. Schatten notes that a colleague has found sperm mitochondria in some defective embryos from infertility clinics.



Inside a fertilized egg, with its two sets of chromosomes (**blue**), the protein ubiquitin (**red**) tags sperm mitochondria (**yellow**).

SOURCE: Sutovsky P, Moreno RD, Ramalho-Santos J, Dominko T, Simerly C, Schatten G. *Nature* 1999;402(6760), 371-2.

The Weekly Newsmagazine of Science

SCIENCE NEWS

July 27, 1996
Vol. 150, No. 4
Pages 49-64

Vaults Hold Cell Mystery

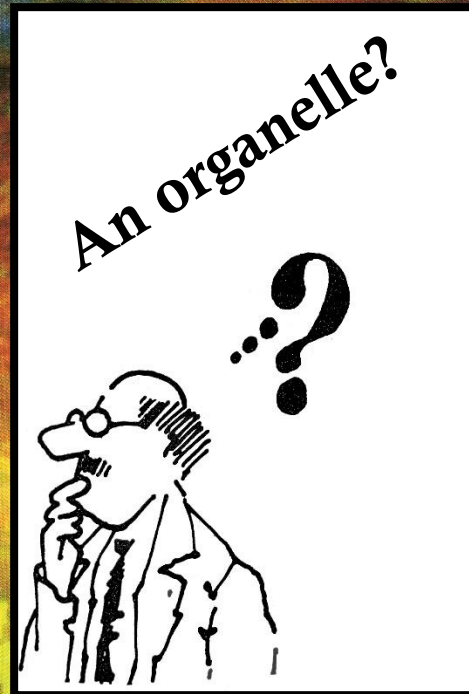

What's in the Vault?

An ignored cell component may often account for why chemotherapy fails

By JOHN TRAVIS

Can you imagine exploring the anatomy of the human body and missing the heart, the organ that sends life-giving blood coursing through the body? Of course not. Or not noticing the brain, the custodian of memories and creator of thoughts? Don't be ridiculous.

Yet cell biologists may soon have to acknowledge an equally unimaginable oversight in their field. For decades, their powerful microscopes have failed to spot a basic cell component of animals and perhaps any organism with a nucleus. Known as vaults, the barrel-shaped particles are three times the size of ribosomes, the org-

through a microscope. But if it were contaminated with objects that shrug off the stain, that sea would be dotted with white islands. Rome likens the strategy to finding an invisible person by looking for an unexplained shadow in the beam of a spotlight.

To Kedersha's surprise, unstained ovoid objects appeared among her coated vesicles. Since some of the stain settled into furrows on top of the unexpected shapes, the negative staining revealed fine details of the exterior of these mysterious interlopers, including arches that reminded Rome and Kedersha of the cell

us something by this incredible structure. And the one thing we might surmise from the structure [of vaults] is that they might contain something," says Rome.

That shape also hints that vaults may pick up their unknown cargo at the nuclear membrane, the barrier that separates the cell's cytoplasm from its nucleus. The nucleus is a fluid-filled sac containing DNA and the machinery required to translate the instructions encoded by that DNA into molecules called messenger RNA. These mRNA strands, as well as other molecules, must somehow get out of the cell.

Sharon Belkin

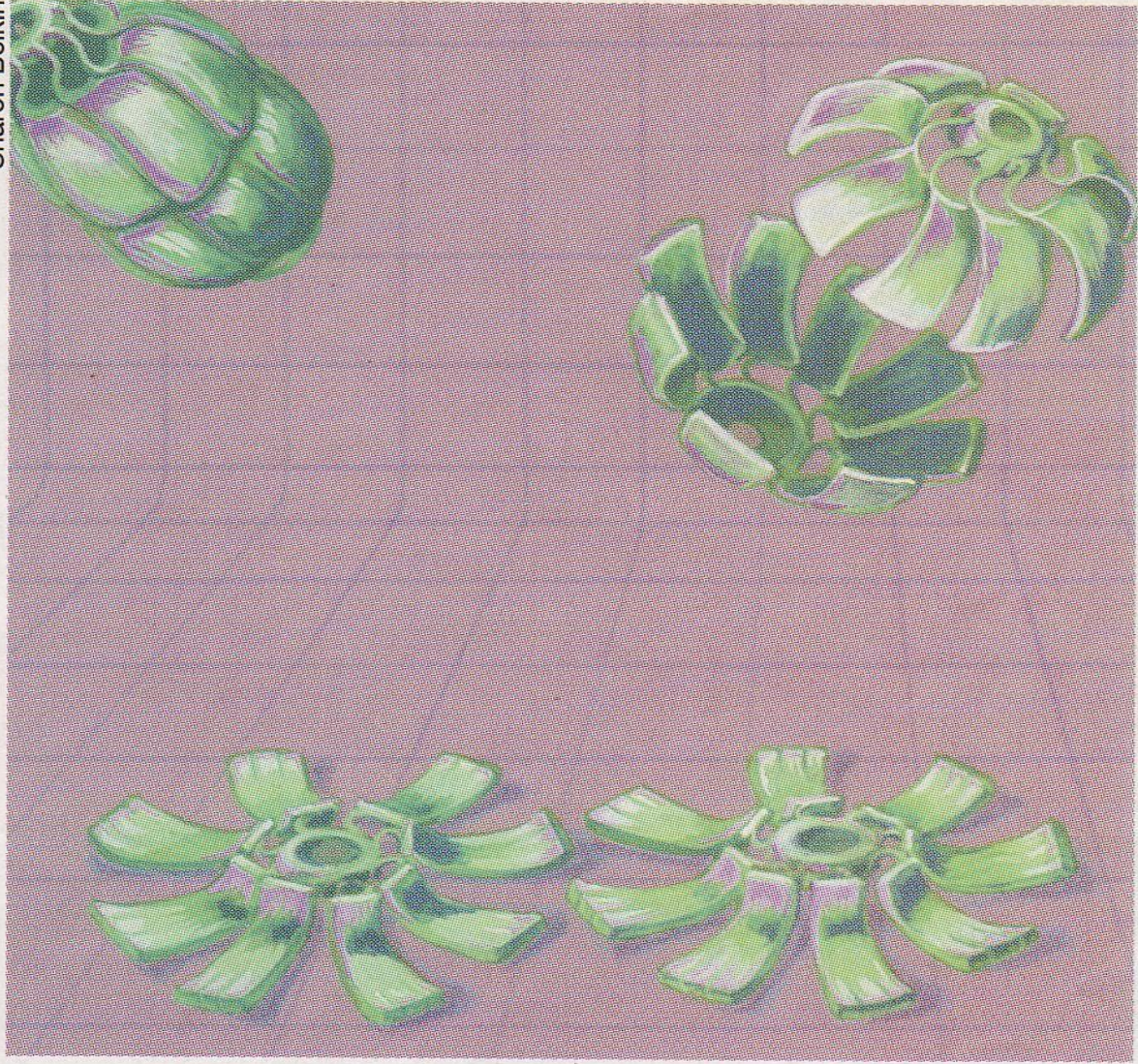

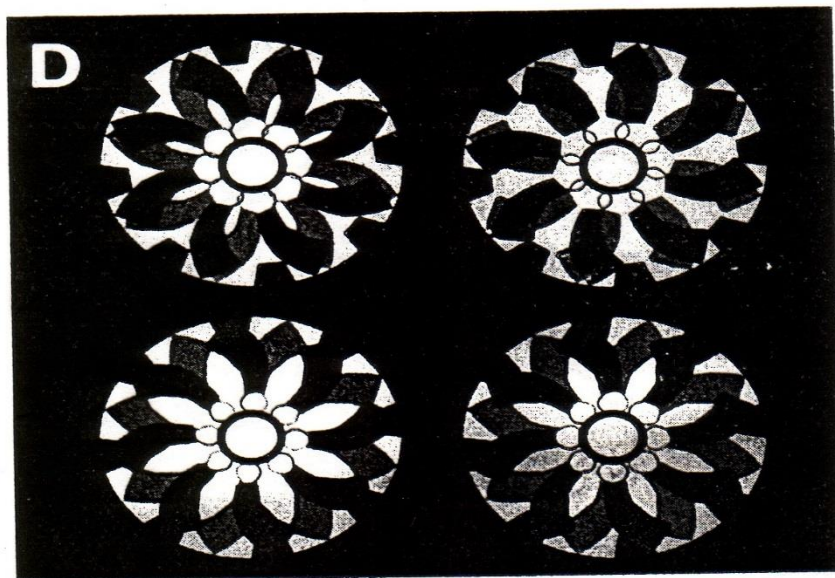
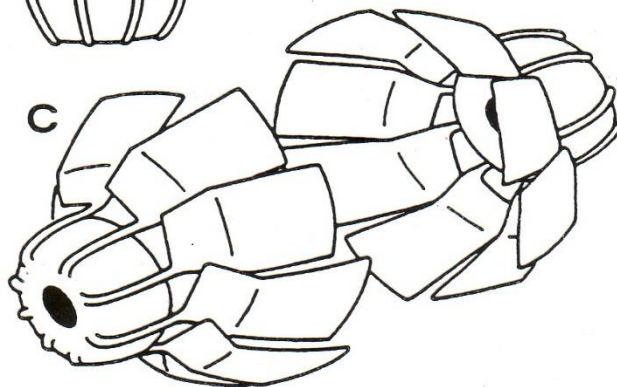
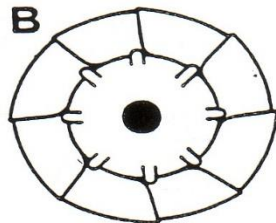
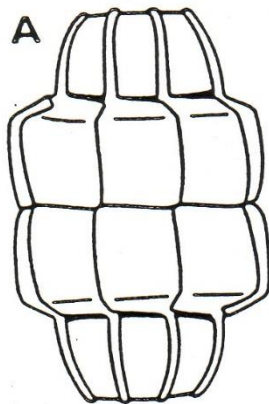



I NEED
A BREAK



but i'd rather have
a breakthrough.

AEROBIC

w/O₂

=

MITOCHONDRION

ANAEROBIC

without O₂

= CYTOSOL



1. Immediate/ATP-PC
2. Glycolysis



WOW!

I'M CHAMP!



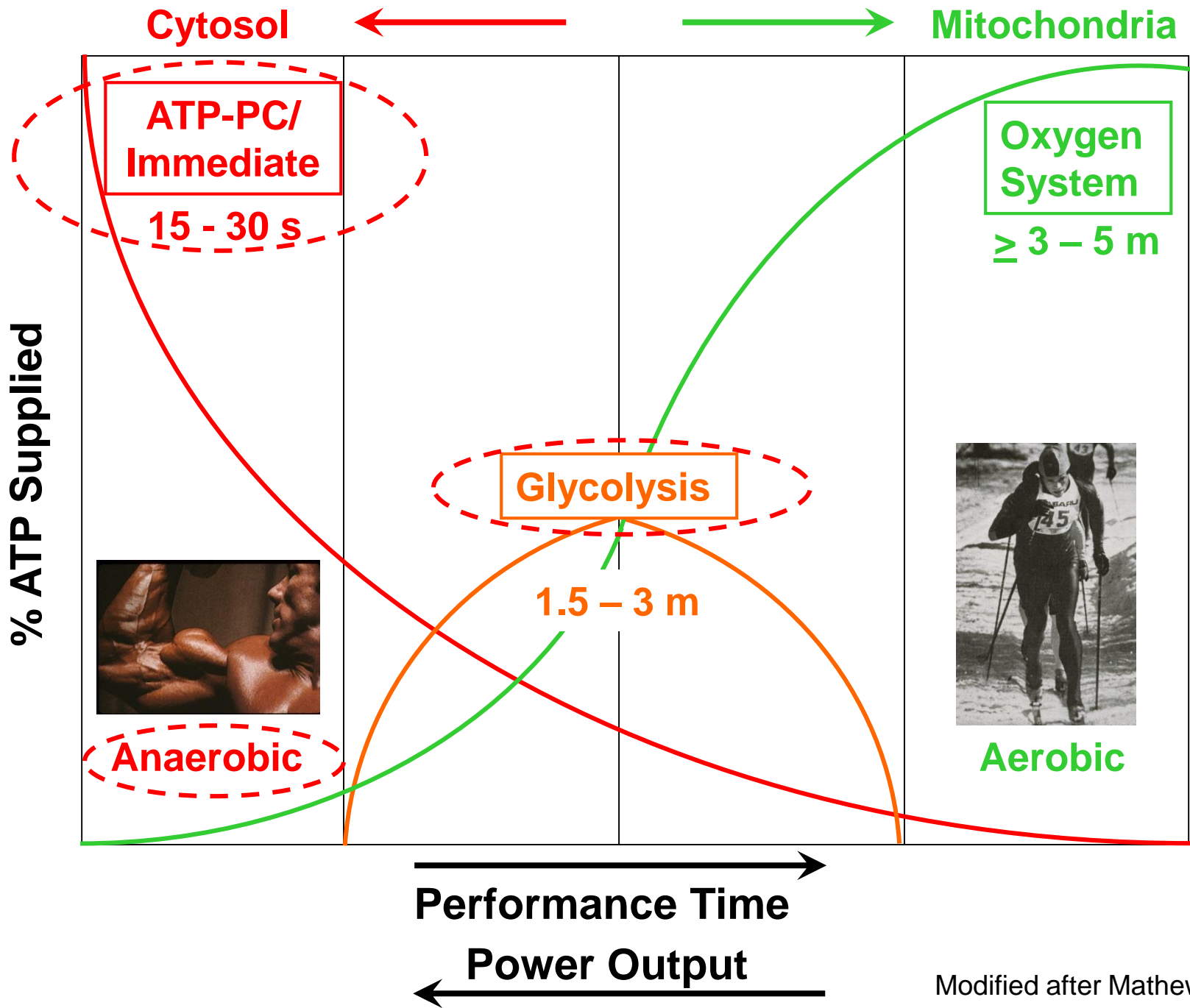

**ATP = Adenosine Tri Phosphate
The Common Energy Currency
or the Cash Cells Understand!!**

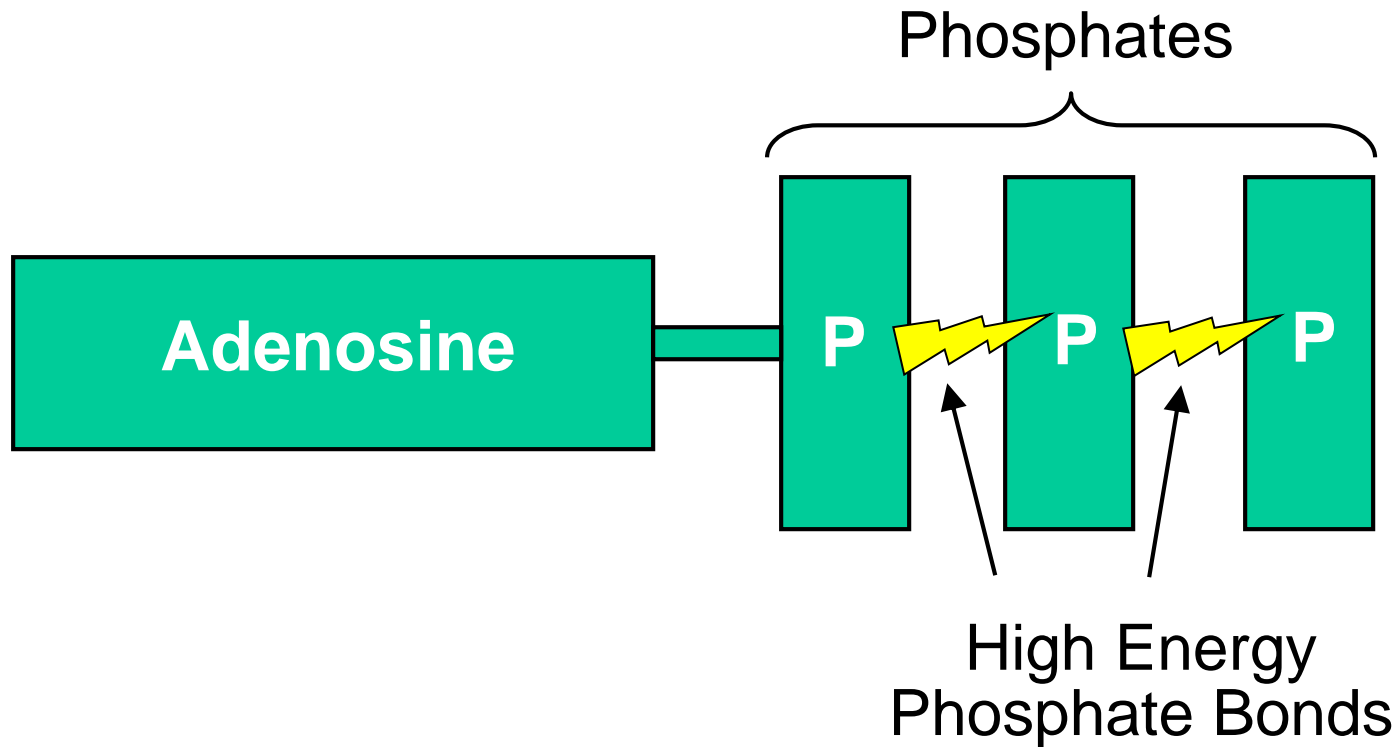

Cleave One High Energy Phosphate Bond To Do Work!!

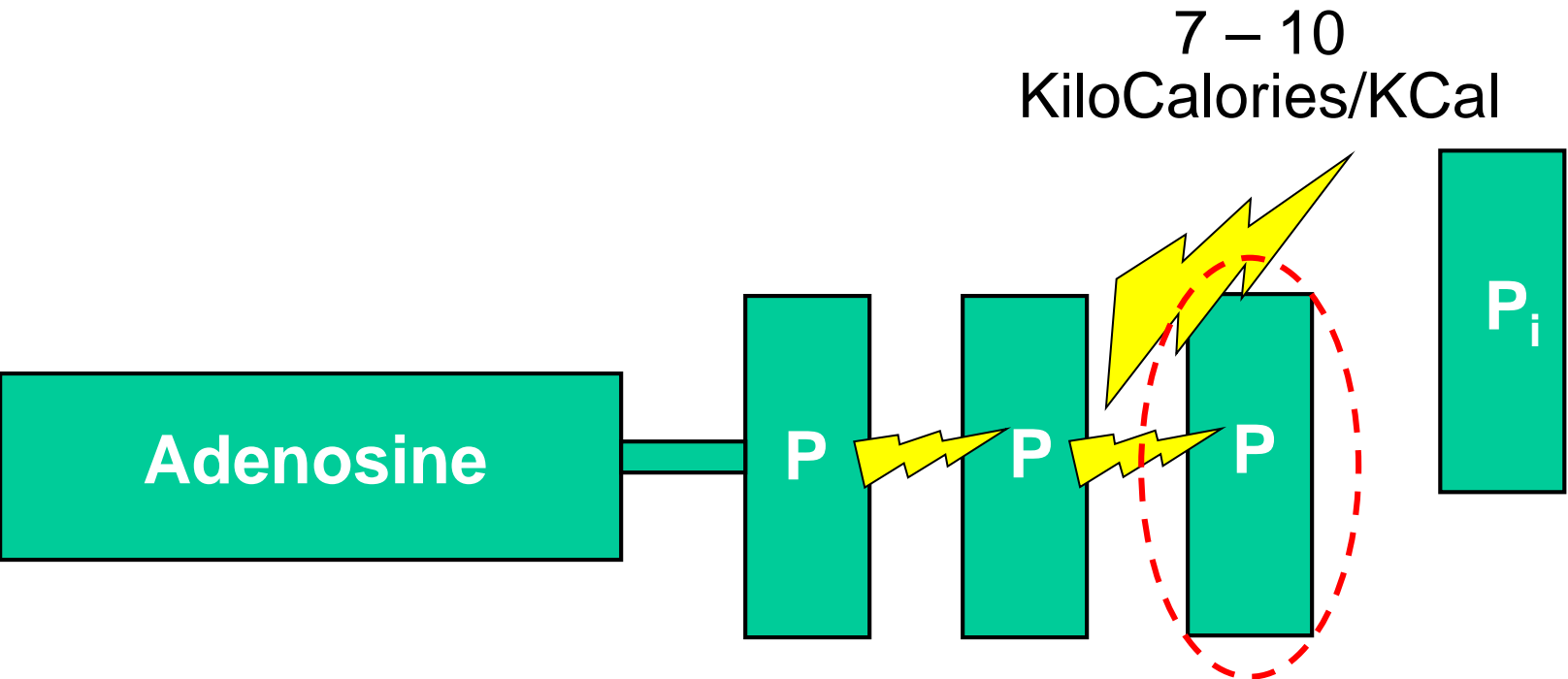

① *Synthesis of Macromolecules*

Make big things from little things!

② *Membrane Transport*

Move things!
Microscopic!

③ *Mechanical Work*

Move things!
Macroscopic!

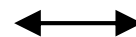

Anaerobic vs. Aerobic Metabolism

Anaerobic conditions

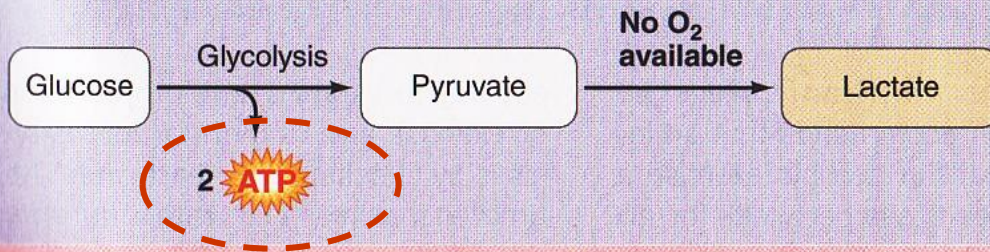

Anaerobic Glycolysis
"sugar dissolving"
without O₂. Net of 2 ATP
per molecule of glucose

Aerobic conditions

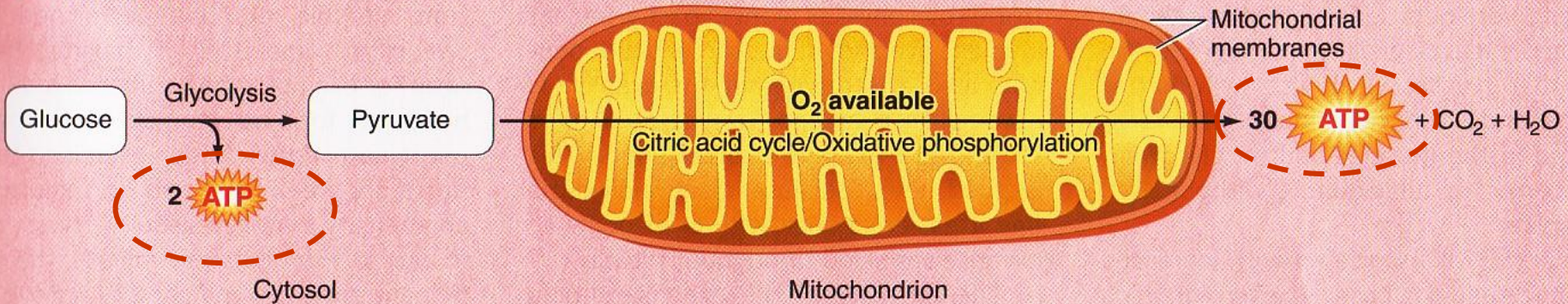

Aerobic Metabolism
+mitochondrial processing of
glucose with O₂. Net of 32 ATP
per molecule of glucose



AEROBIC

w/O₂

PRIMARY FUEL

FAT,
CARBOHYDRATE
& PROTEIN
(Small Amounts)

CARBOHYDRATE
(Glucose & Glycogen)

ATP, ADP &
Creatine
Phosphate (CP)

% AEROBIC
(Oxidative
Energy System)

% ANAEROBIC
(Immediate & Non-Oxidative
Energy Systems)

ACTIVITY

TIME (Min:Sec)

ACTIVITY	% AEROBIC (Oxidative Energy System)	% ANAEROBIC (Immediate & Non-Oxidative Energy Systems)	TIME (Min:Sec)
Marathon	100	0	135:00
Cross-Country Skiing	90	10	29:00
10-K Run	80	20	14:00
3-Mile Run	70	30	9:00
2-Mile Run	60	40	3:45
800-Meter Swim	50	50	3:45
1-Mile Run	40	60	1:30
Boxing	30	70	1:30
200-Meter Swim	20	80	0:50
Circuit Weight Training	10	90	0:20
Soccer	0	100	0:10
Lacrosse			
Tennis			
Basketball			
Volleyball			
200-Meter Dash			
Football			
Conventional Weight Training			

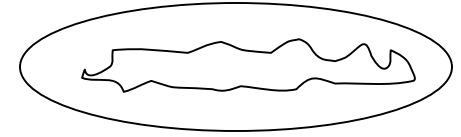

MITOCHONDRIA

CYTOSOL

Glycolysis



Immediate/ATP-PC



ANAEROBIC

Stages of Cellular Metabolism/Respiration

**Anaerobic
Glycolysis
Cytosol**

**Aerobic
Metabolism
Mitochondria**

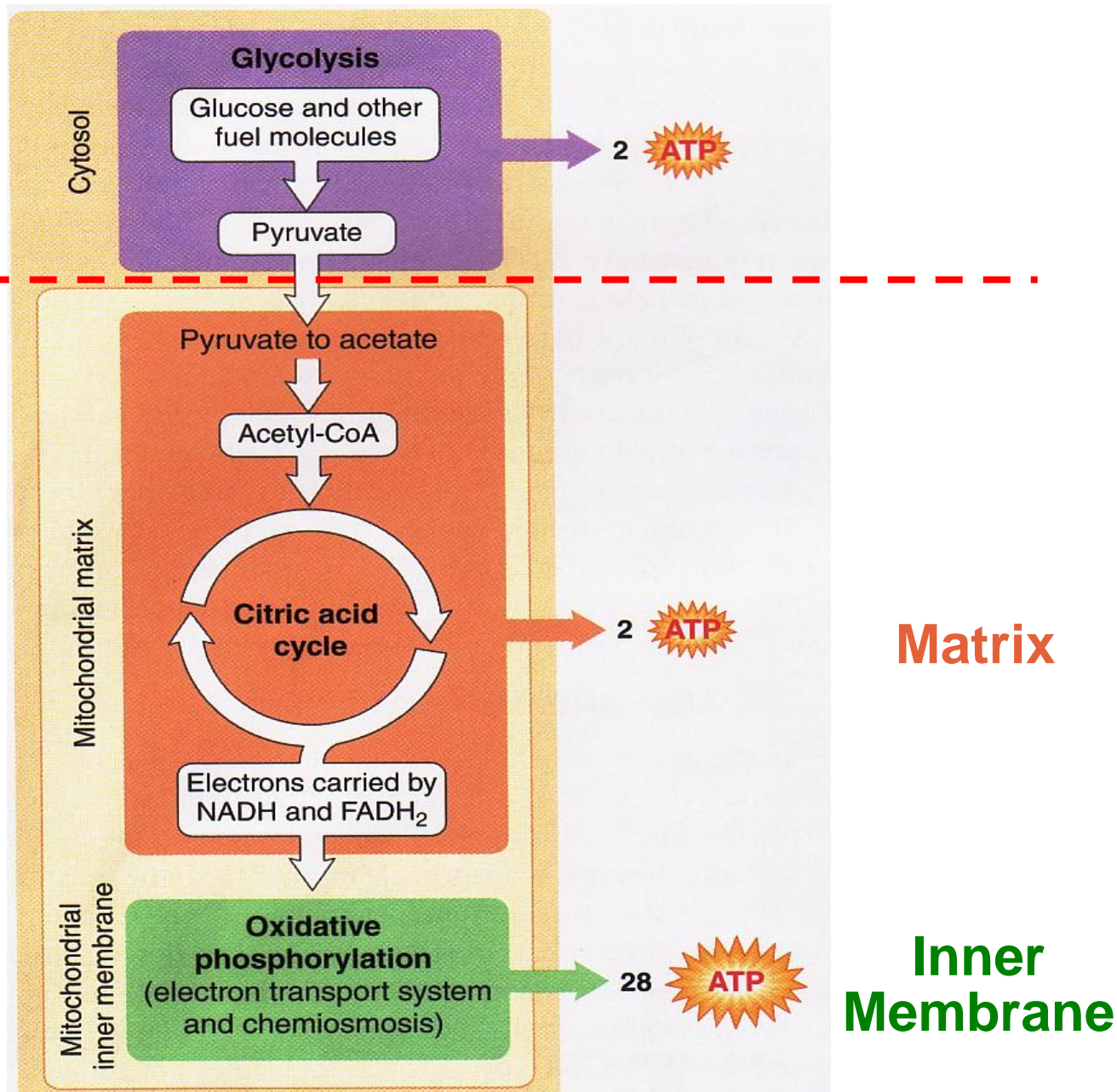

fig 2-9 LS 2012

Glycolysis "sugar dissolving/splitting" produces small amounts of ATP

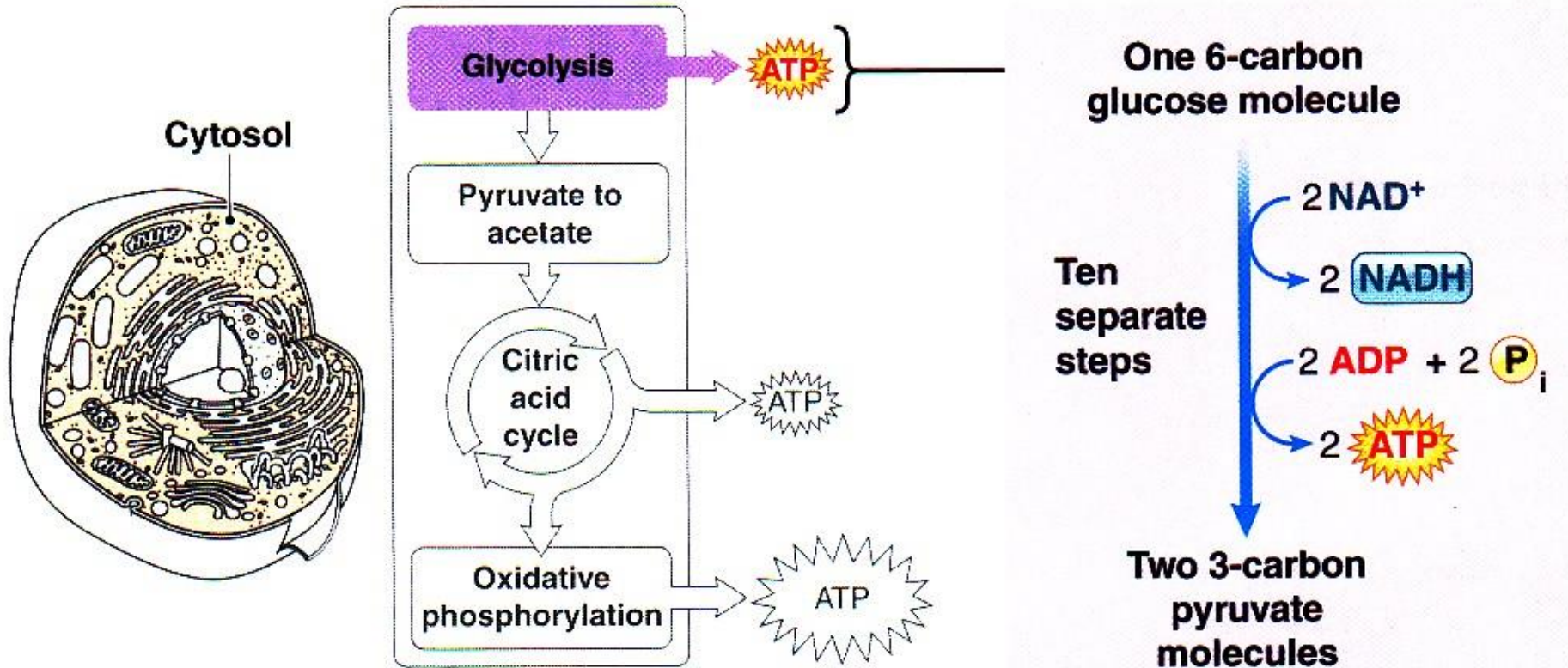

fig 2-10 LS 2012

Citric Acid Cycle
produces pairs of
electrons for cashing in
at the nearby electron
transport chain (ETC)

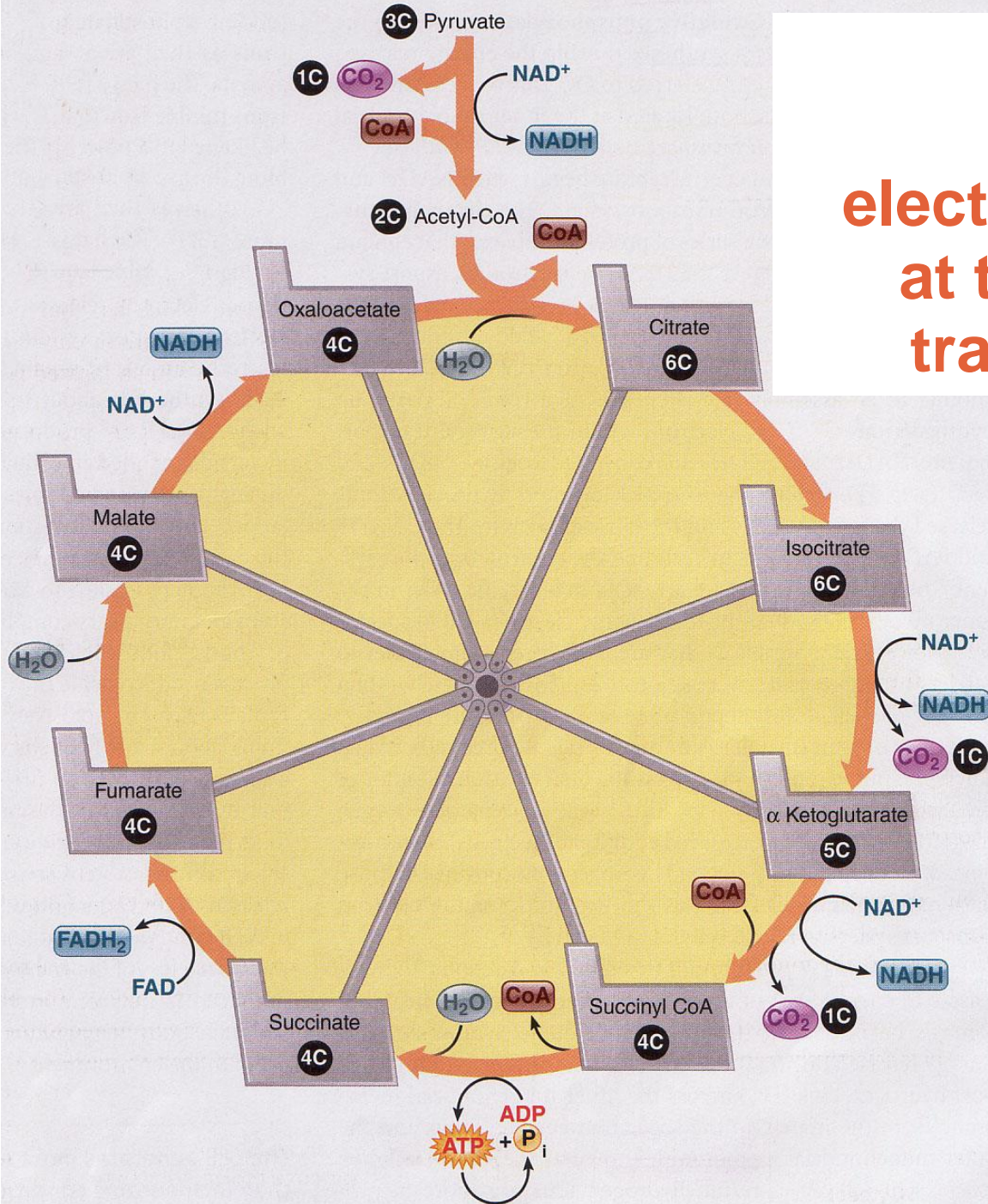

fig 2-11 LS 2012
+ David Oganessian
<http://pixdaus.com>

Cashing in electrons at the Electron Transport Chain (ETC) produces an abundance of ATP energy molecules!

Cytosol

Outer mitochondrial membrane

MitoSciences®

Rod Capaldi
U of O Biology



Inner
...

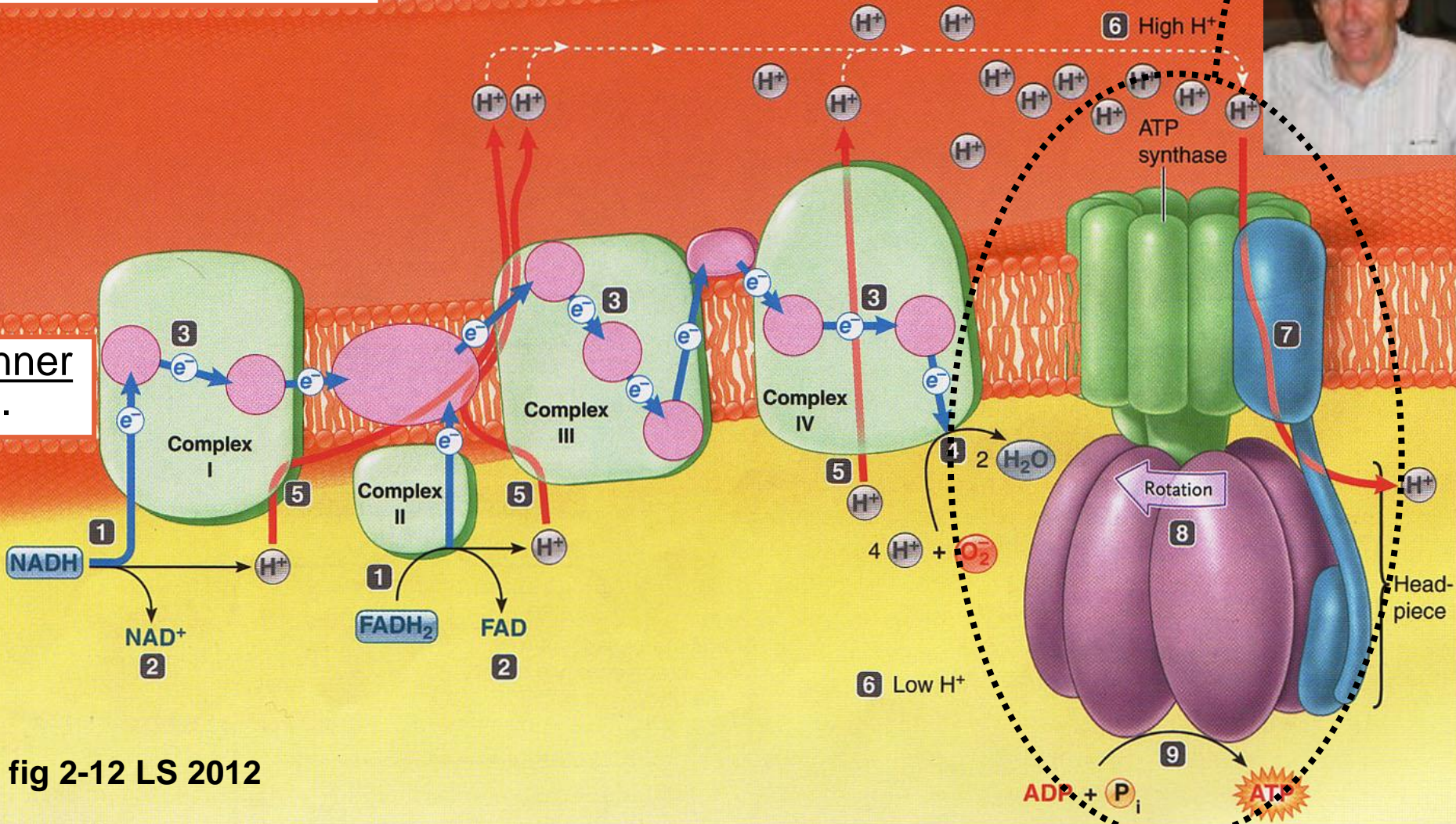

fig 2-12 LS 2012

Goals of Aerobic Metabolism

AEROBIC

=

MITOCHONDRION

w/O₂

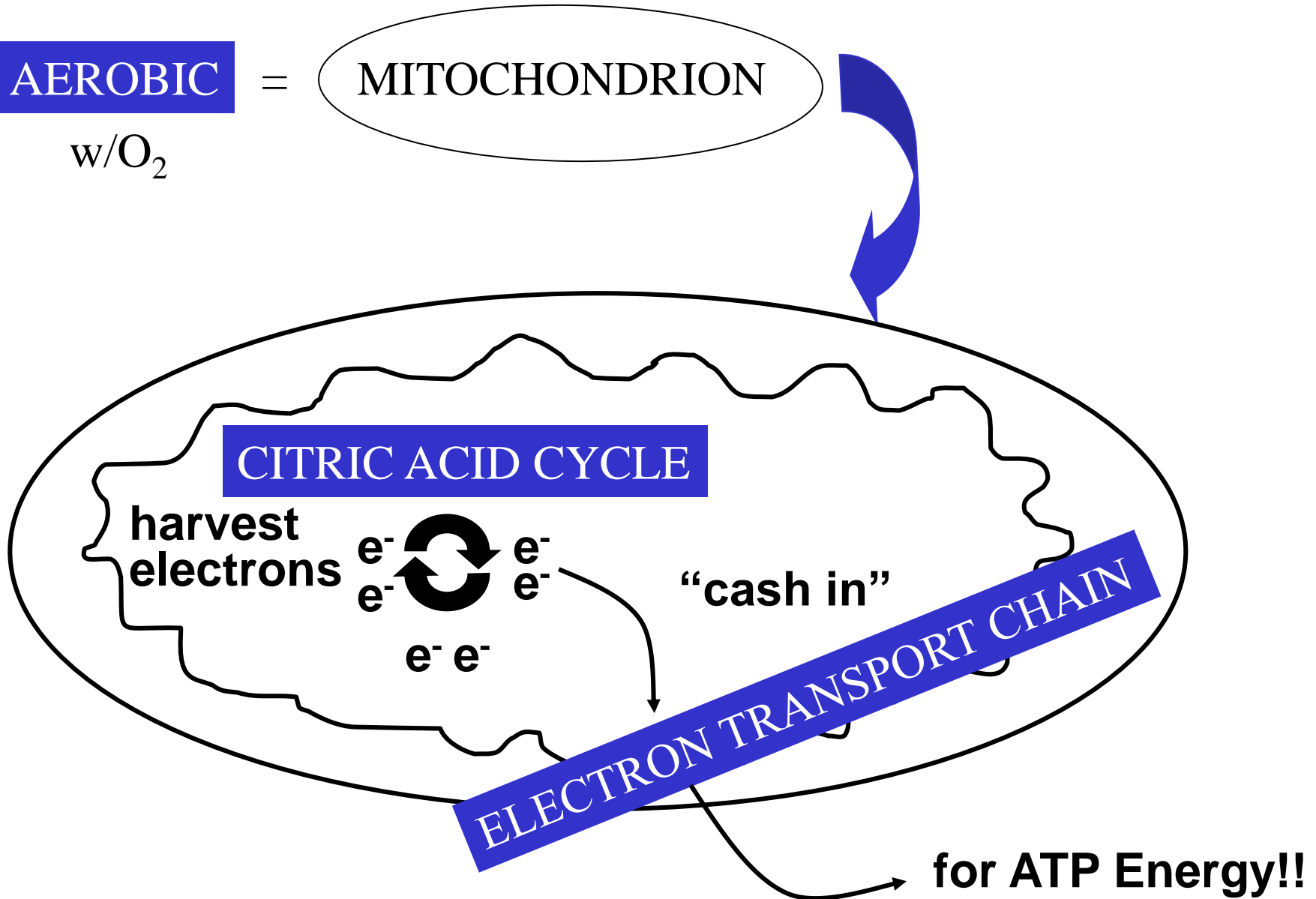

Cytoskeleton: Cell "Bone & Muscle"

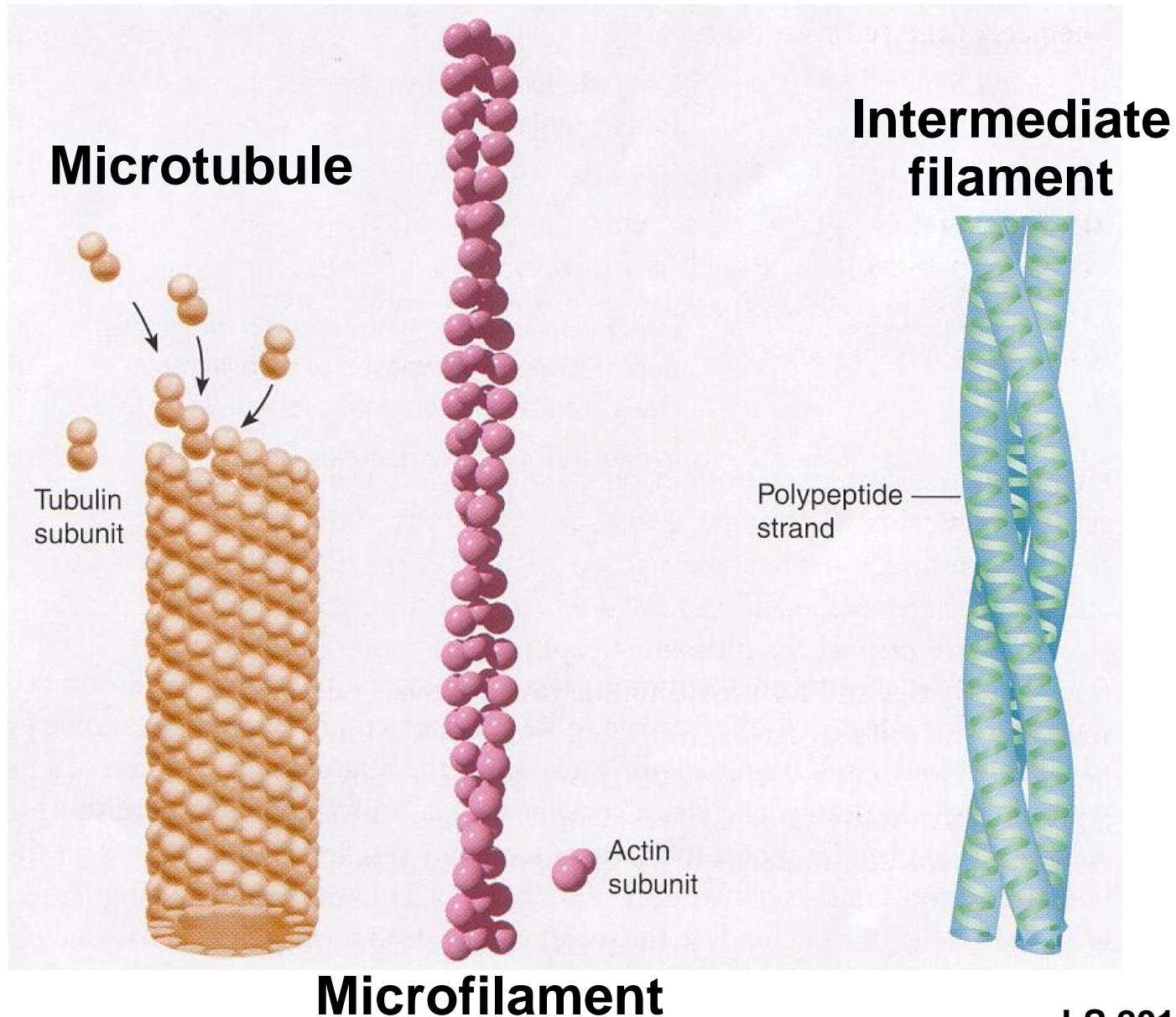

Microtubular Highway!!

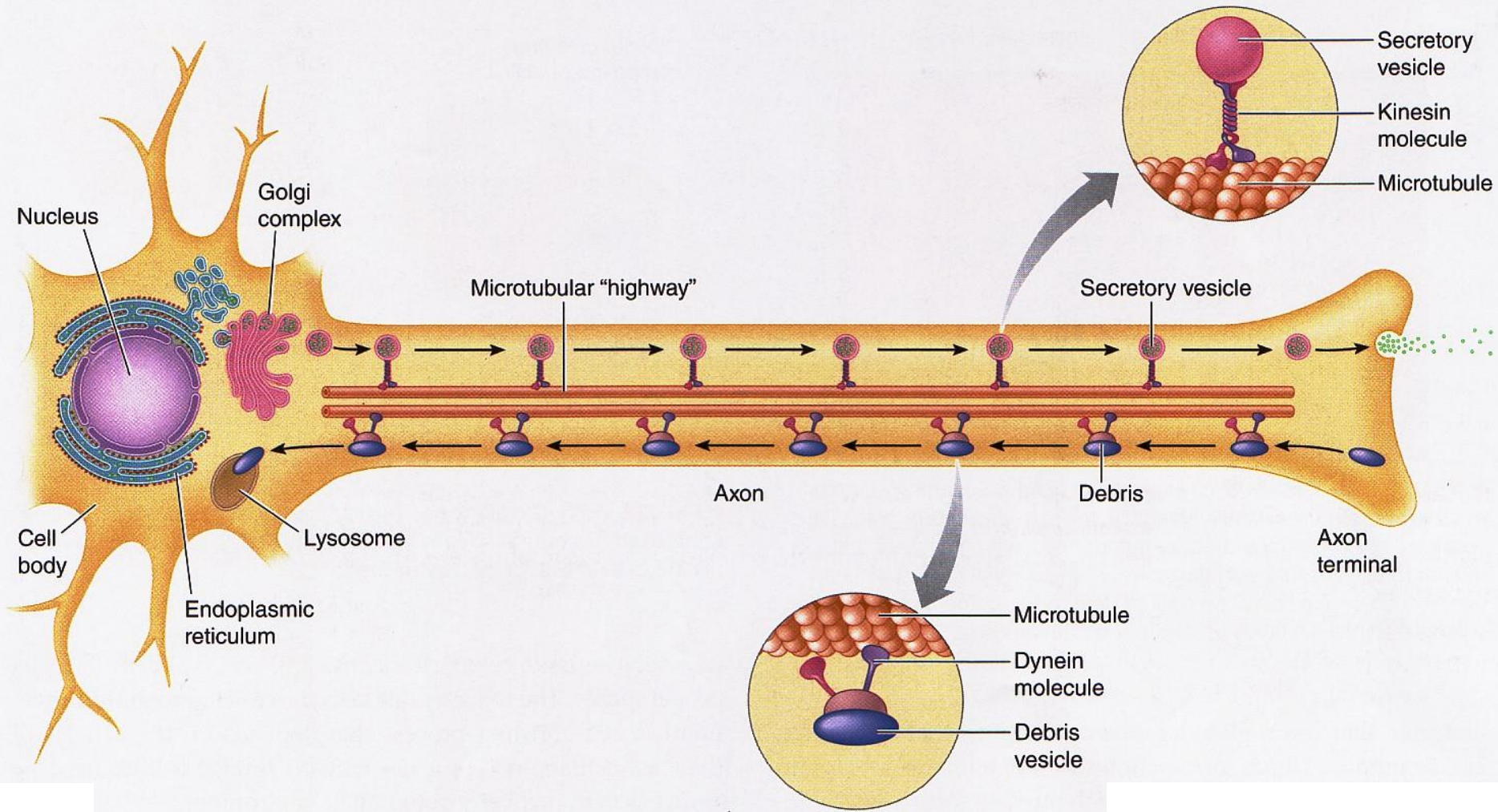

4th Component: Microtrabecular Lattice?

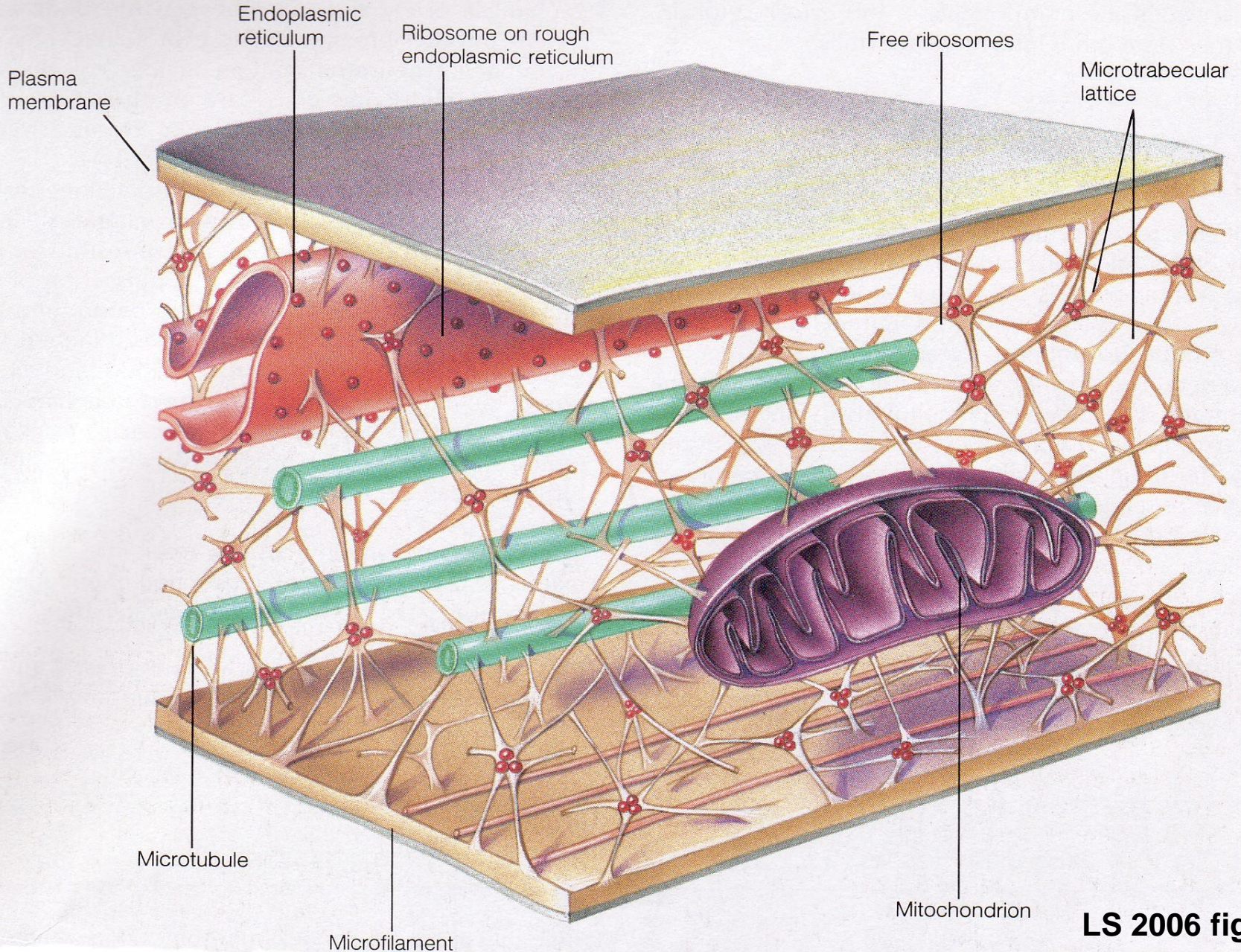

Time-out for questions!

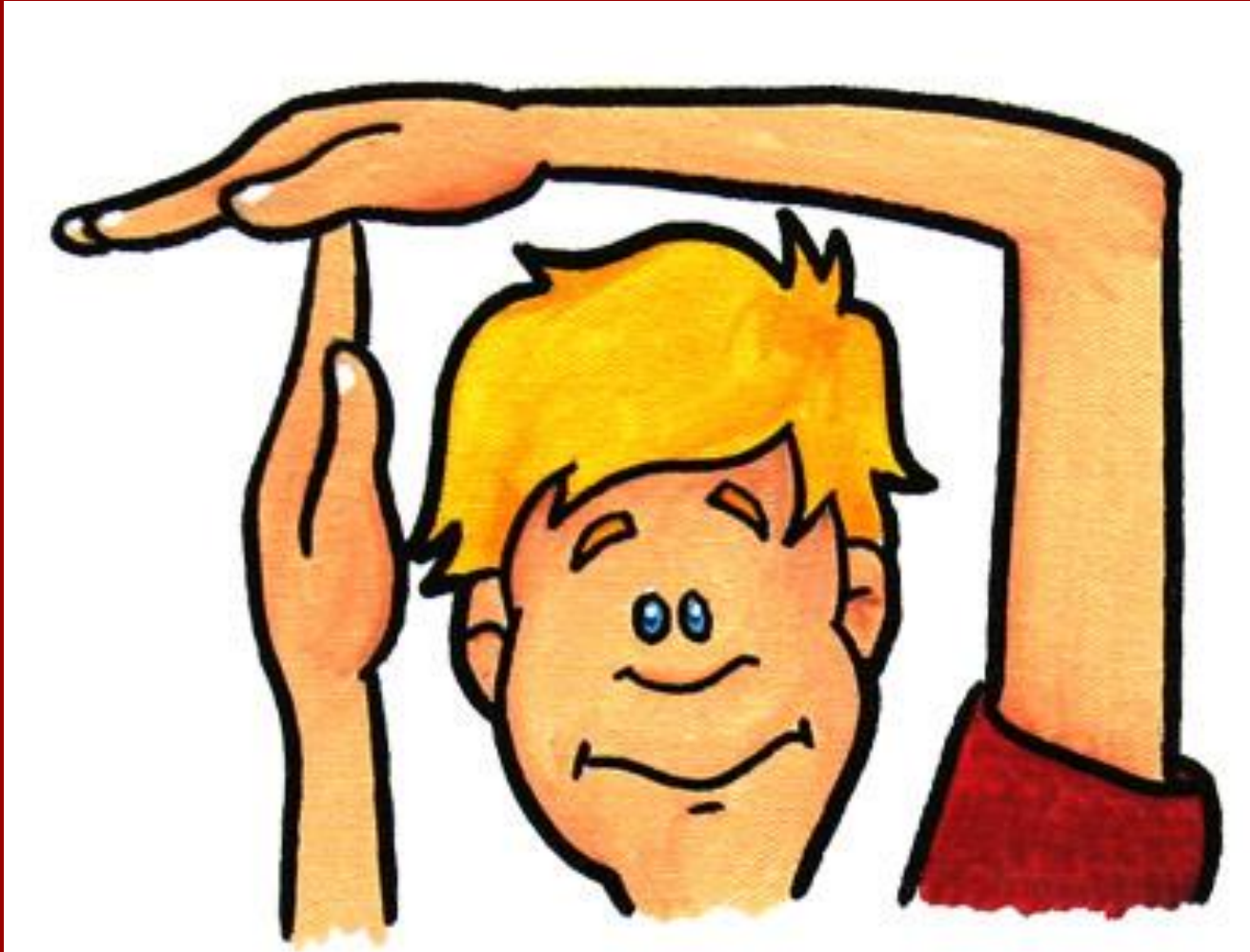

What are DNA's major functions? Heredity + Day-to-Day Cell Function



What does DNA look like? Double-helix!!

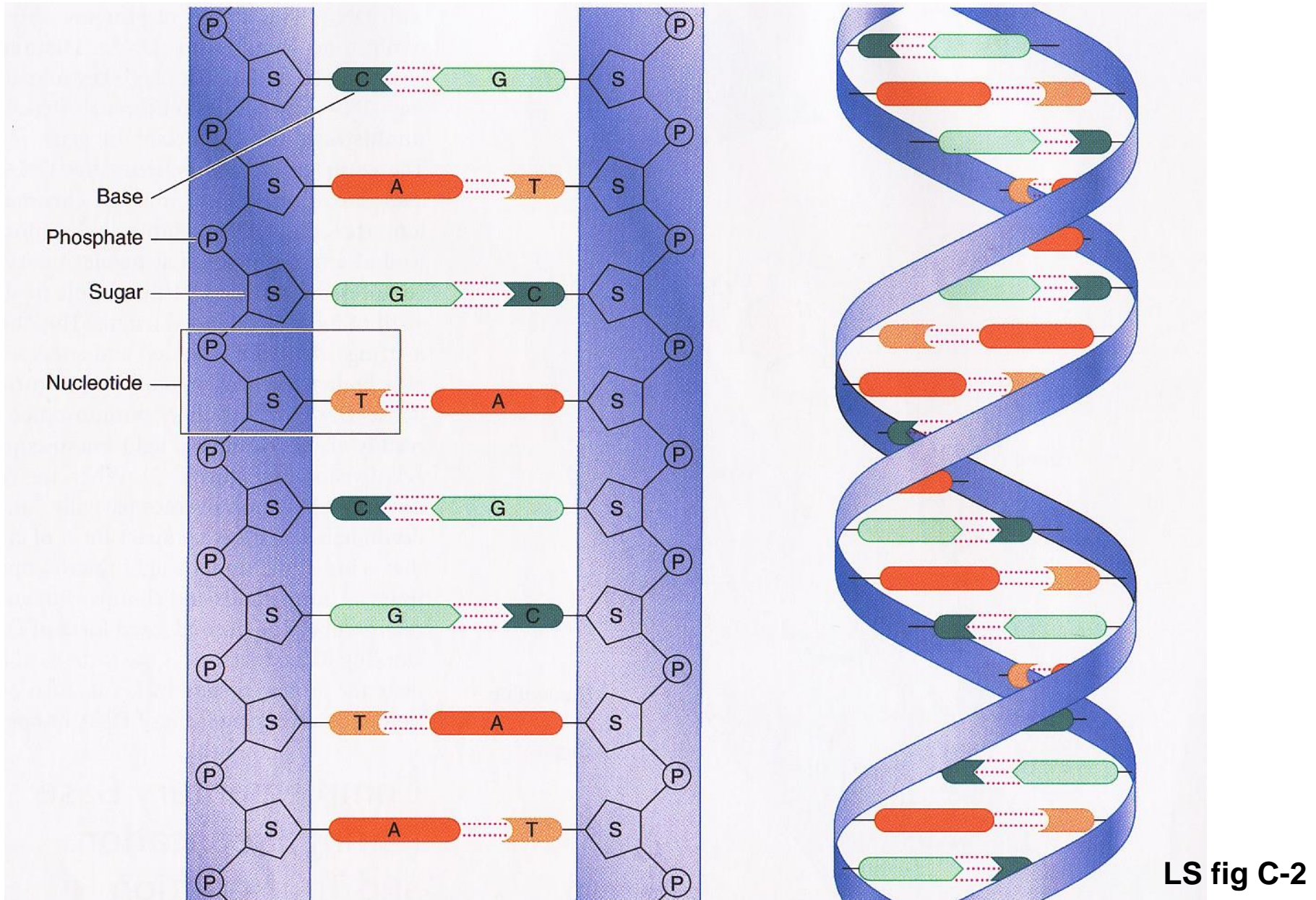

Gene = *Stretch of DNA that codes for a protein*

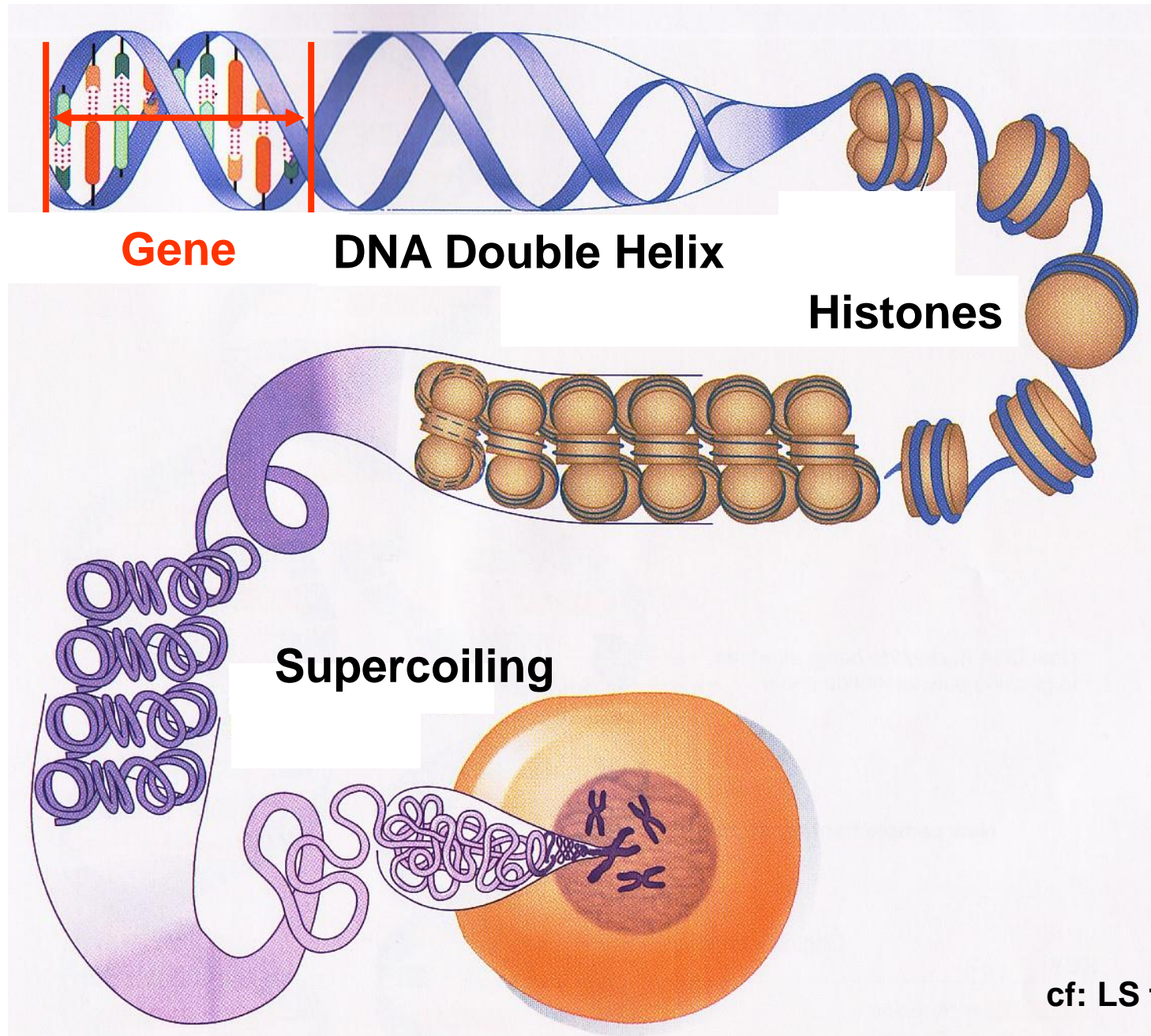

What does DNA do, day-to-day?

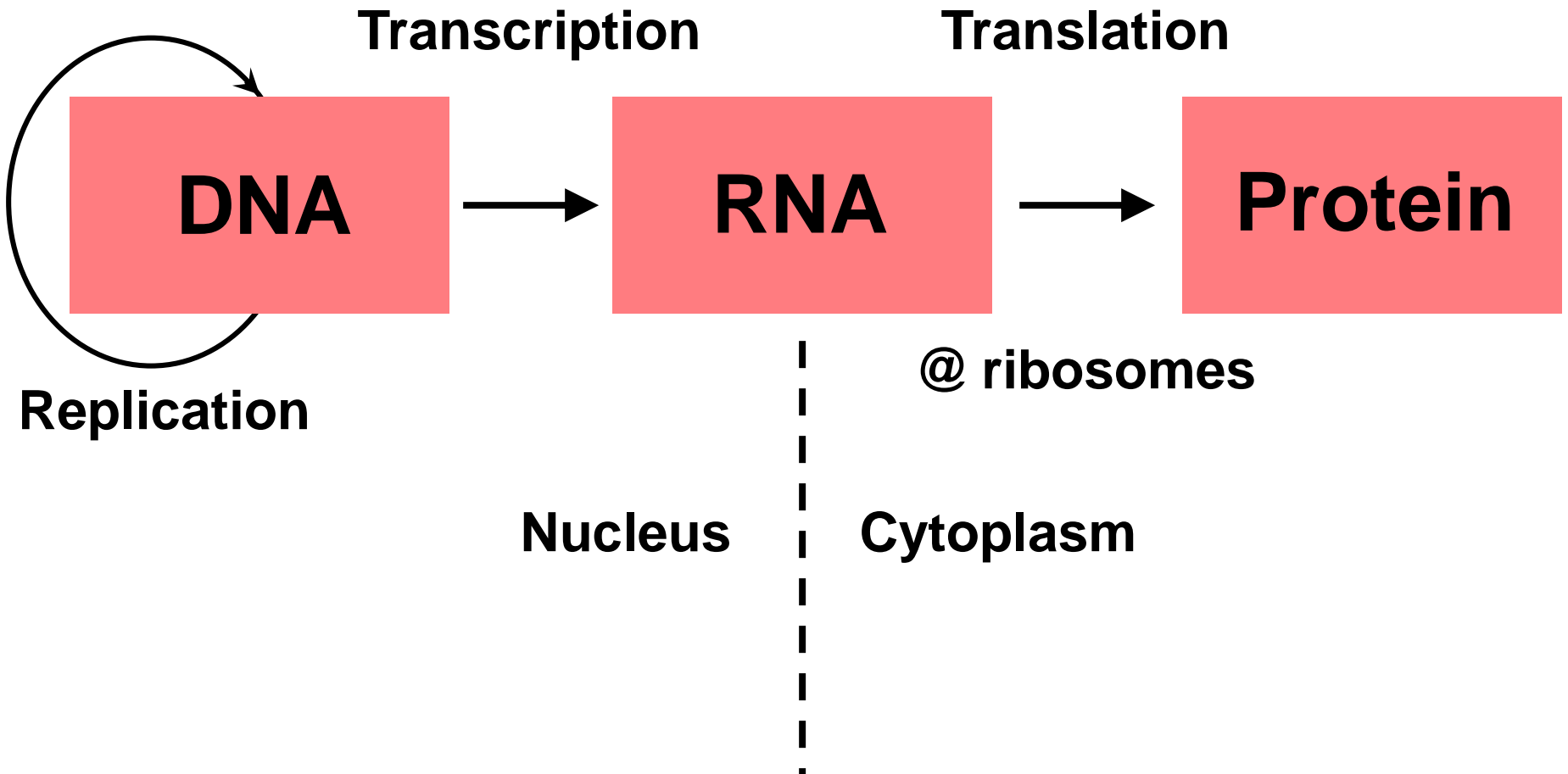

DNA vs RNA?

1. Double-stranded

2. Deoxyribose
(without oxygen)

3. A, T, C, G
Thymine

4. Self-replicative
(can copy itself)

5. Nucleus
(+mitochondria)

1. Single-stranded

2. Ribose
(with oxygen)

3. A, U, C, G
Uracil

4. Needs DNA as
template

5. 1^o Cytoplasm
(but Nucleus origin)

6. mRNA, rRNA, tRNA

*Triplets of bases code for amino acids,
the building blocks of proteins*

DNA

mRNA

tRNA

code word

codon

anti-codon

TAT

AUA

UAU

ACG

UGC

ACG

TTT

AAA

UUU

TAC

AUG

UAC

		Second base of codon							
		U	C	A	G				
First base of codon	U	UUU } Phe UUC } UUA } Leu UUG }	UCU } Ser UCC } UCA } UCG }	UAU } Tyr UAC } UAA } Stop UAG } Stop	UGU } Cys UGC } UGA } Stop UGG } Trp	U	C	A	G
	C	CUU } Leu CUC } CUA } CUG }	CCU } Pro CCC } CCA } CCG }	CAU } His CAC } CAA } Gln CAG }	CGU } Arg CGC } CGA } CGG }	U	C	A	G
	A	AUU } Ile AUC } AUA } AUG } Met Start	ACU } Thr ACC } ACA } ACG }	AAU } Asn AAC } AAA } Lys AAG }	AGU } Ser AGC } AGA } Arg AGG }	U	C	A	G
	G	GUU } Val GUC } GUA } GUG }	GCU } Ala GCC } GCA } GCG }	GAU } Asp GAC } GAA } Glu GAG }	GGU } Gly GGC } GGA } GGG }	U	C	A	G

Translation? Ribosomes Make Proteins

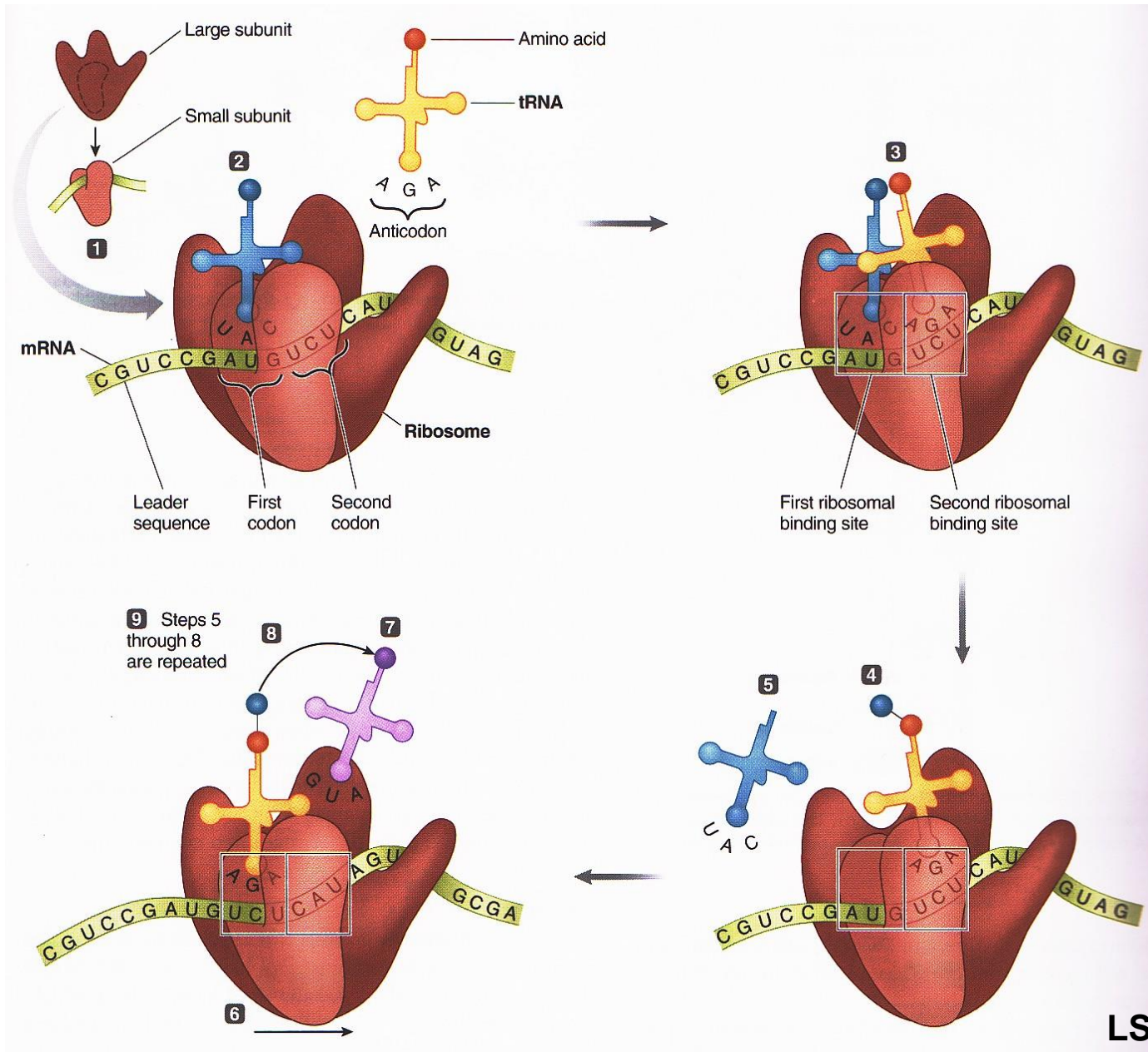

Transfer RNA (tRNA)

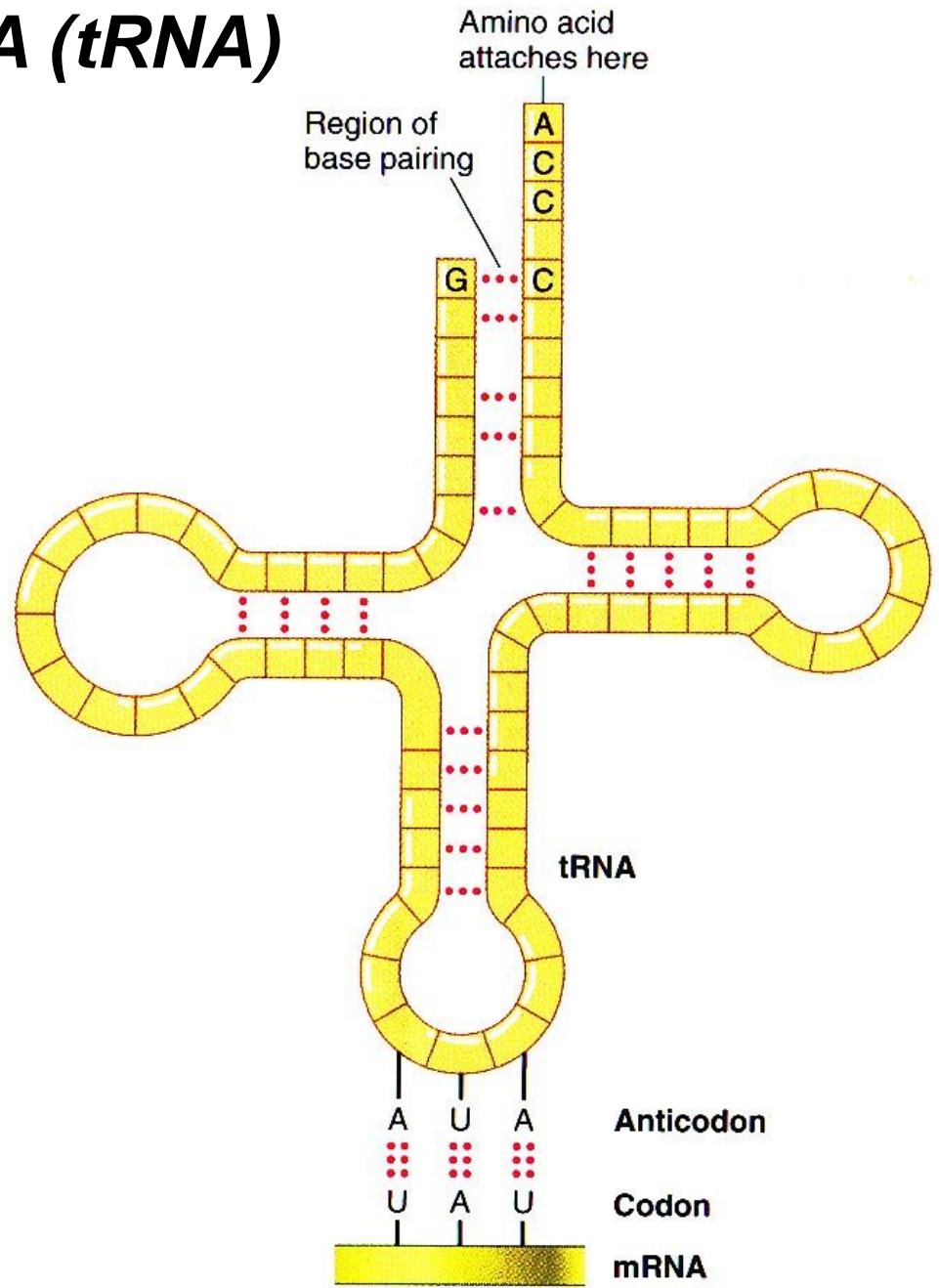

LS fig C-8

A Polyribosome. Which Way is Synthesis?

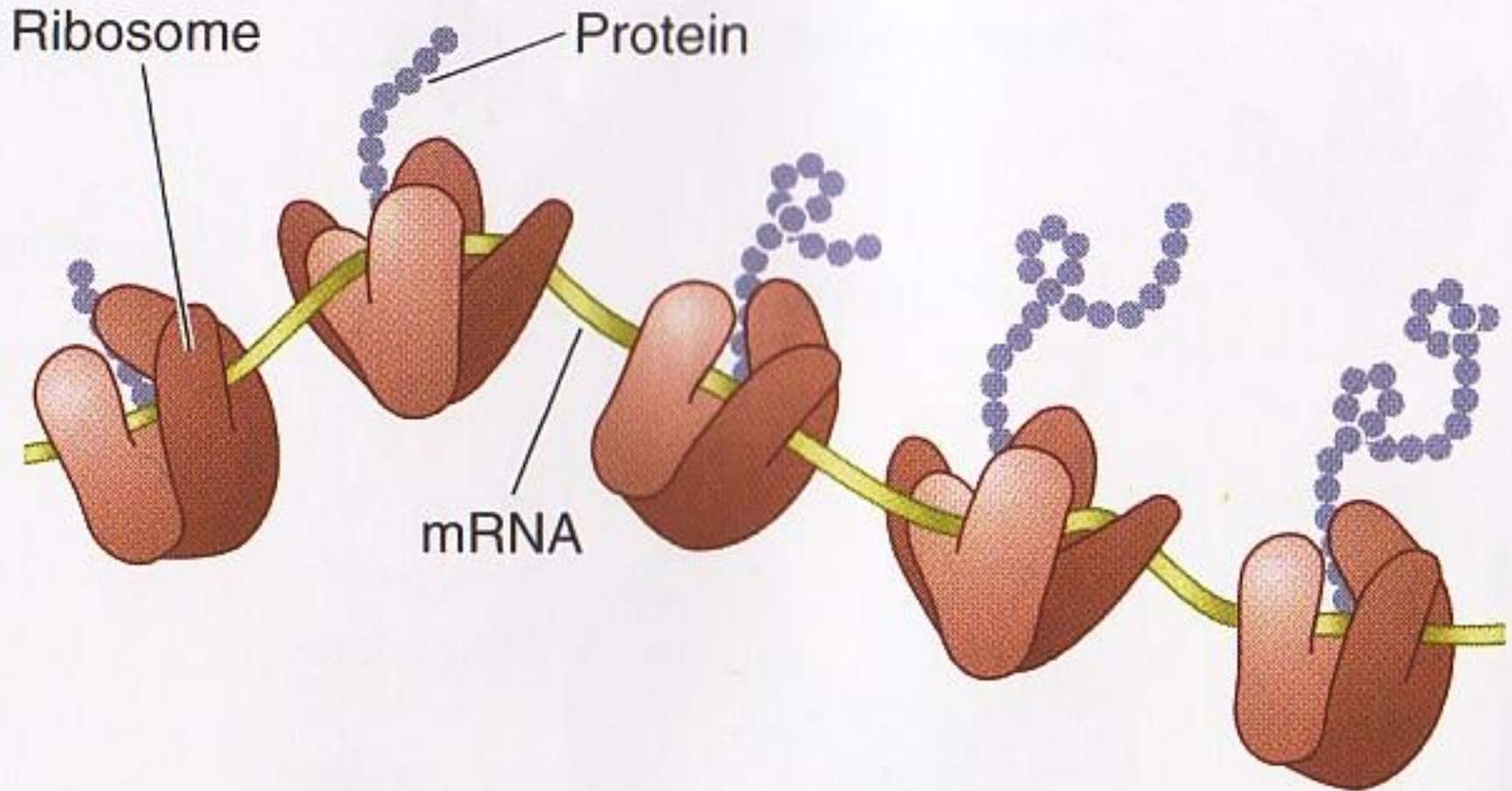

Questions + Discussion

