

BI 121 Lecture 2



...Histology exploratory fun!!
Thanks for signing in!



- I. Announcements Lab today 12 n & 1 pm. Q last time?
- II. Connections Extracellular fluid (ECF) & Homeostasis
 - A. ECF: Plasma vs. Interstitium?
 - B. Dr Evonuk Balances LS pp 5 - 15
 - C. Physiology in the News Are we like watermelons?
 - D. Simplified Model DO Norris cf: fig 1- 8 LS
 - E. Negative feedback? Positive feedback? LS pp 14 - 15
 - F. Balances & e.g. H₂O, T°C, BP Dr Evonuk + LS pp 8 - 10
- III. Cell Anatomy, Physiology & Compartmentalization ch 2 (LS)
 - A. How big? What boundaries? Why compartments? pp19-21
 - B. Basic survival skills ch 1 p 3
 - C. Organelles ≡ Membranous, cytoplasmic specialty shops!
 1. Endoplasmic Reticulum (ER) 2. Golgi 3. Lysosomes
 4. Peroxisomes & 5. Mitochondria. LS 2012 pp 20-34
 - fig 2-1, 2-2, 2-3, 2-4, 2-5, 2-6, 2-7, 2-8 pp 20-7 tab 2-1 p 36
 - D. Physiol News Moms eggs execute Dad's mitochondria?
 - E. What about vaults? LS 2006, p 32 + *Science News*

Where is extracellular fluid?

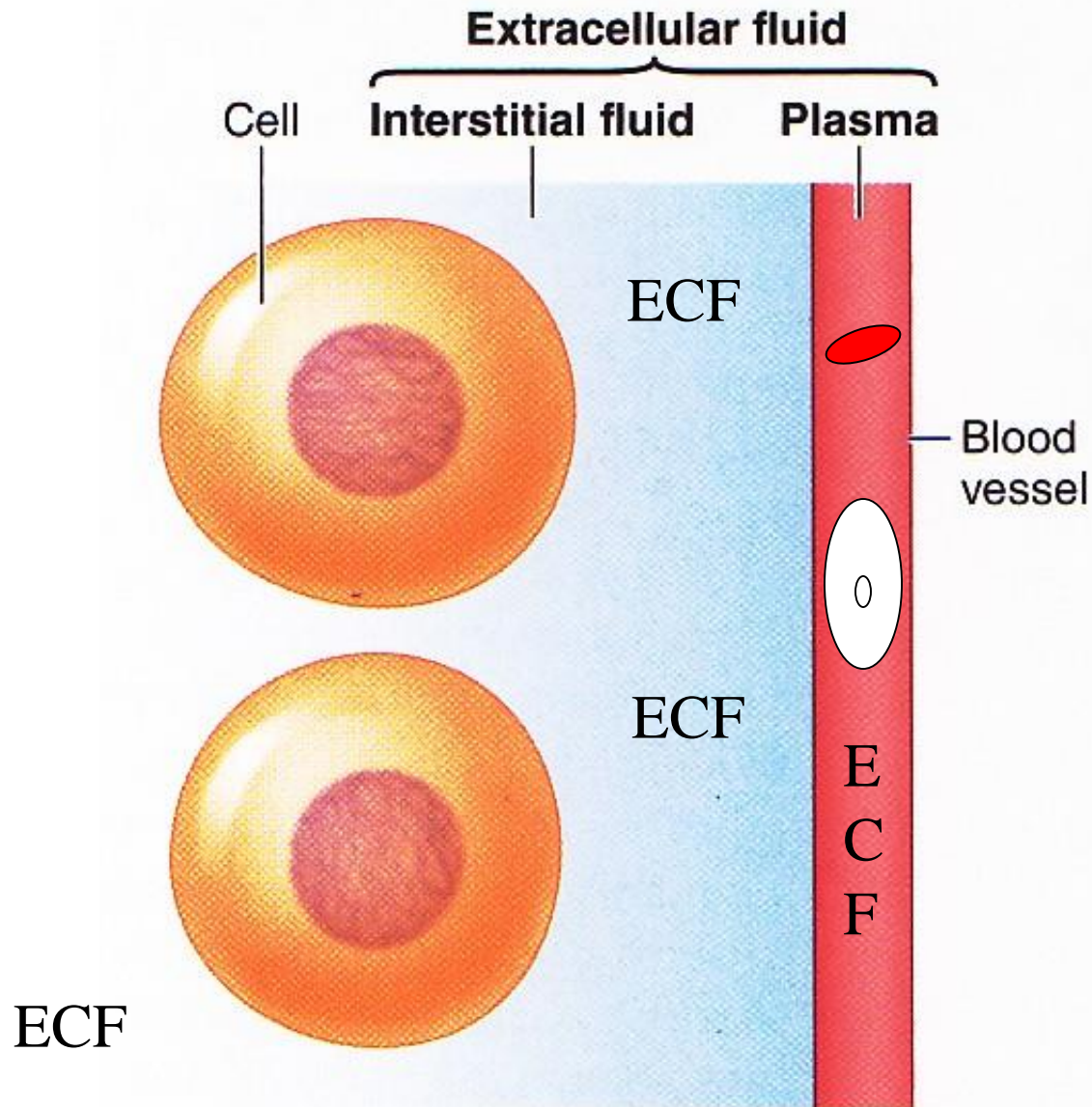

Where is extracellular fluid?

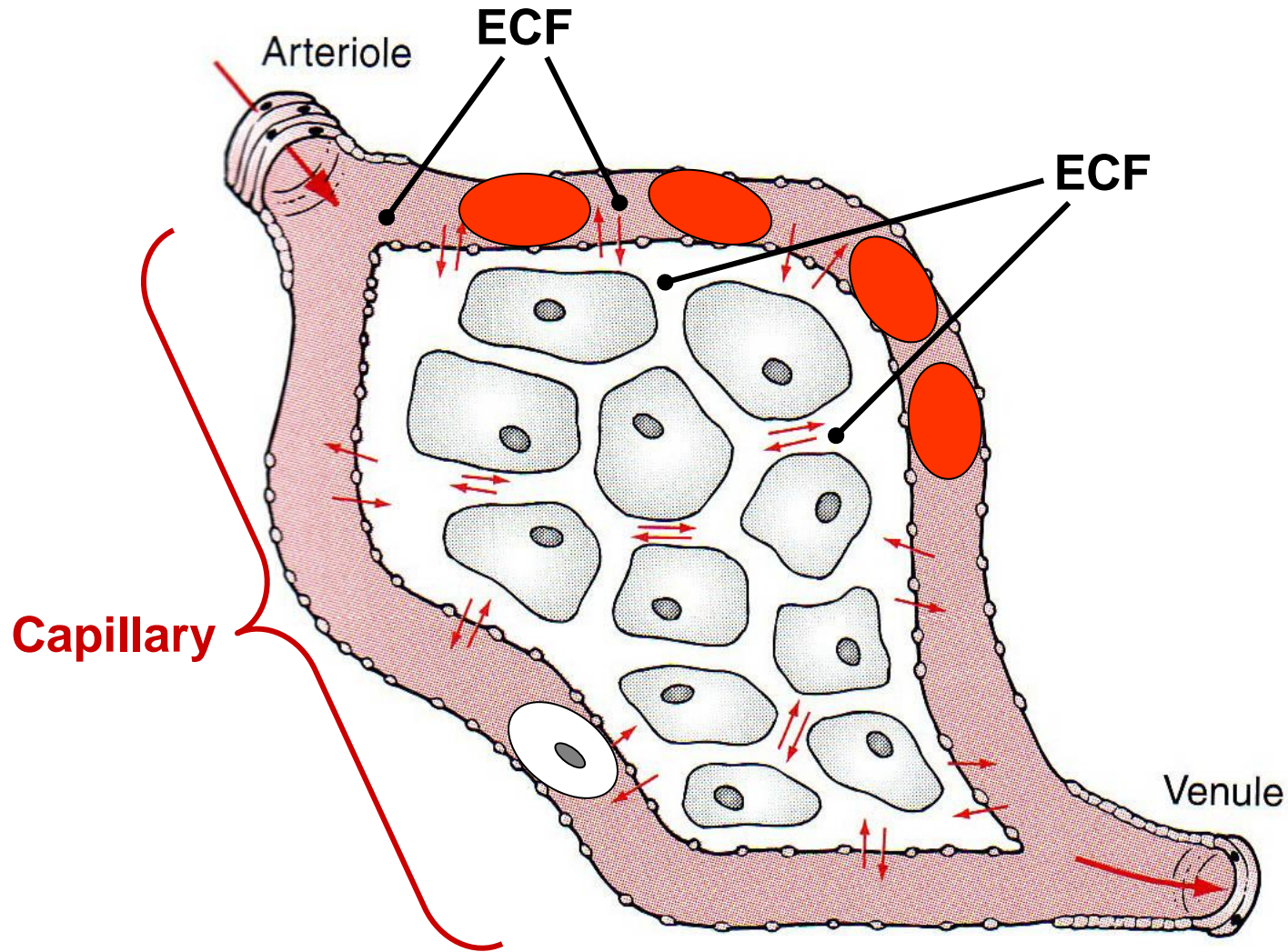

As long as between/outside cells, **ECF everywhere?**

ECF = Extracellular

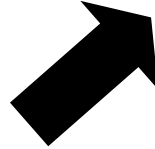

Plasma
(within CV System)

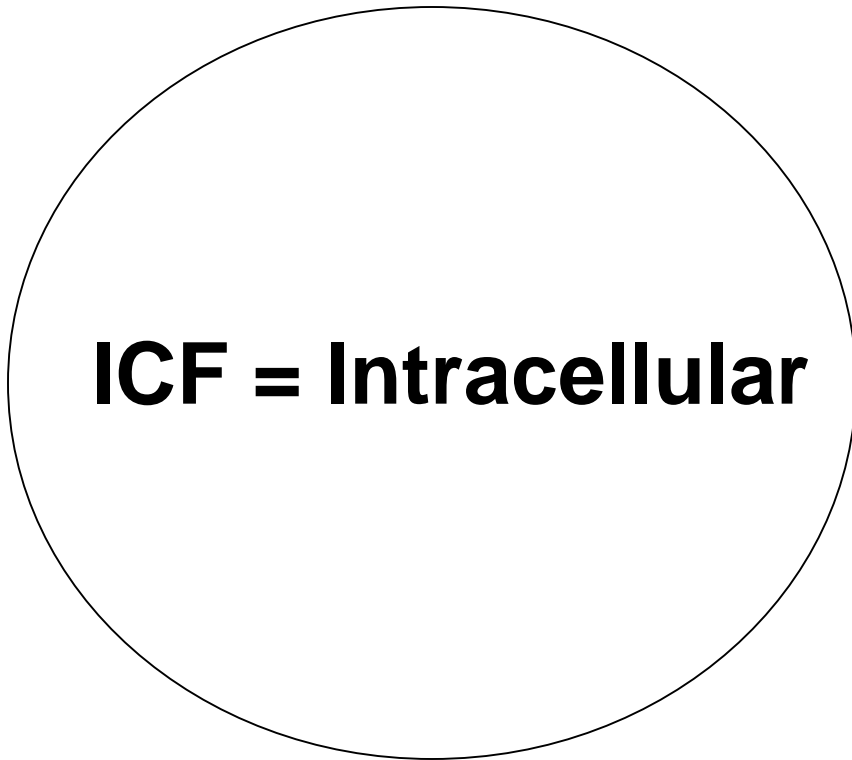

ICF = Intracellular



Interstitium
(eg, between
muscle cells)

HOMEOKINESIS?



Metabolic

ANA-

CATA-

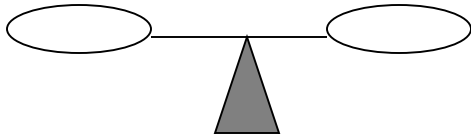

H₂O



T_oC



Dr. Evonuk's 6 Balances

O₂/CO₂

Carbon Dioxide

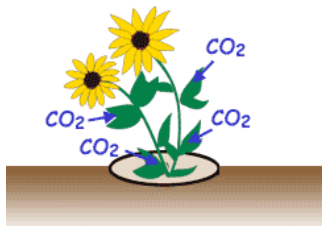

Ion^{+/-}



Captain Calcium



pH

Bicarbonate and pH Balance

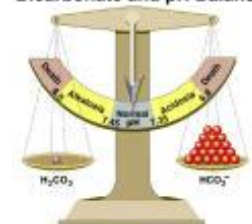

No, we're not watermelons,
but H₂O is definitely critical!!

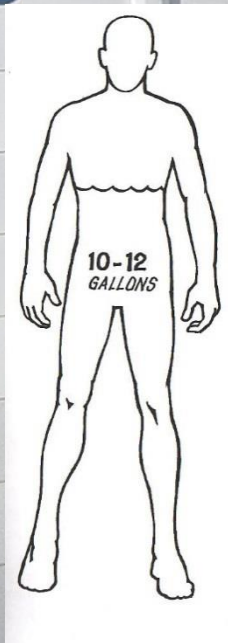

≠



because
you're 98%
water.



Drink about 1 L per 1000 calories energy expenditure!!

Human ~ 2/3 H₂O
~ 60 – 70 %

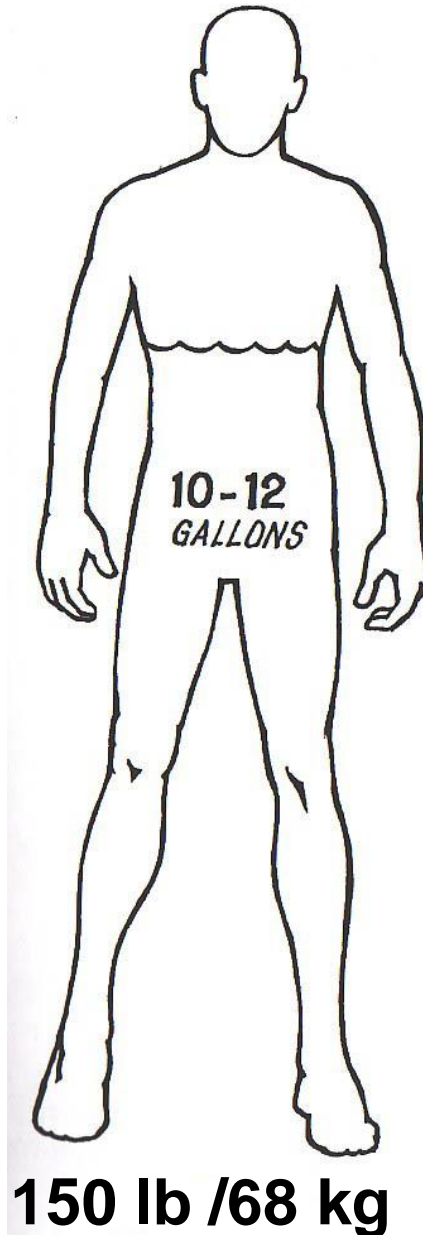

NB: So 2000 kcal →
drink 2000 mL
≡ 67.63 fl oz
≡ ~ 8 cups!

= ~40 – 48 kg H₂O

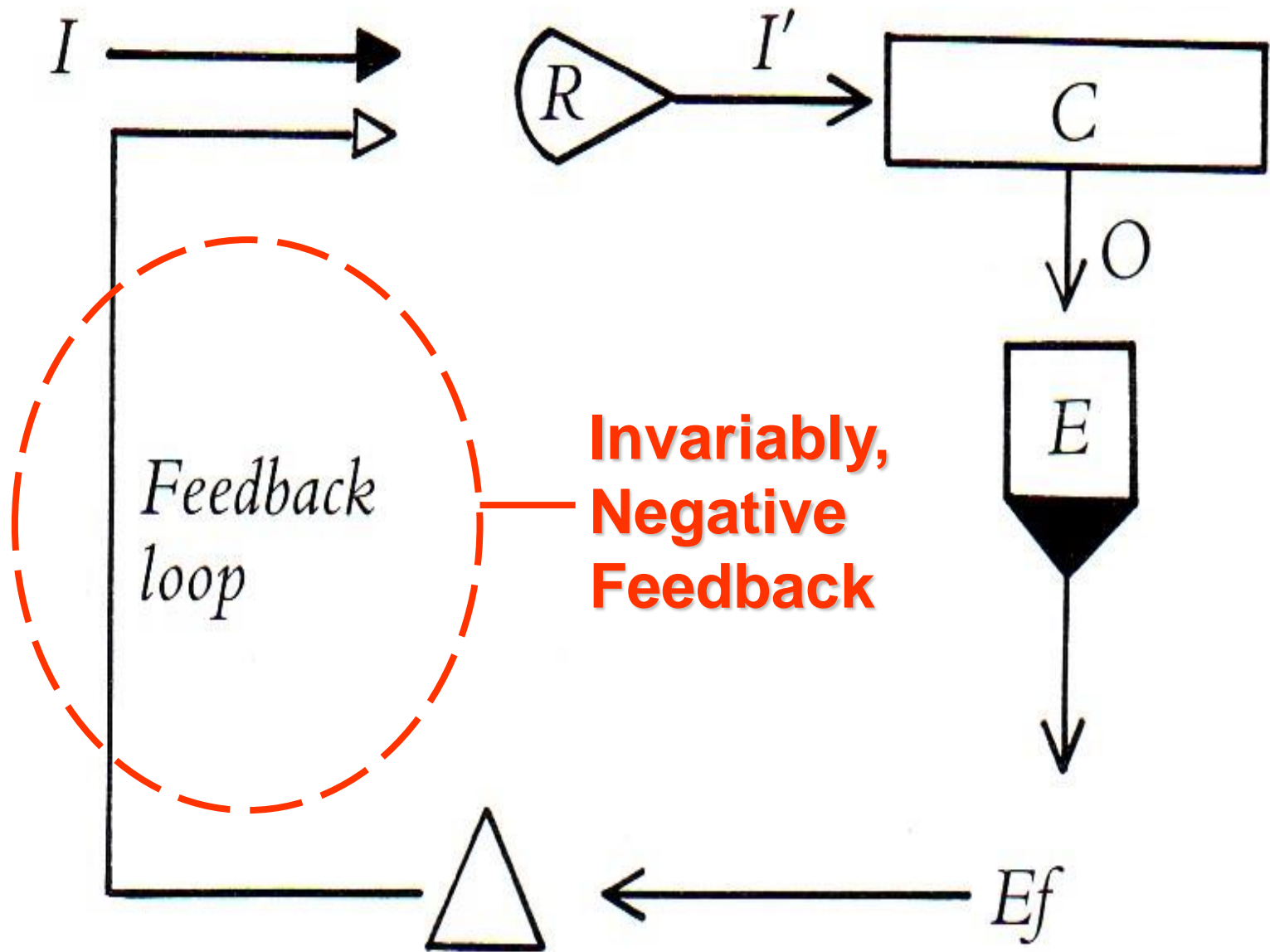

NB: Though most often **negative** feedback, there are exceptions:

Selected +FB eg:

LH Surge + Ovulation

Oxytocin + Uterine Contraction

Blood Clotting Cascade

cAMP Cascade

Na⁺ influx during AP

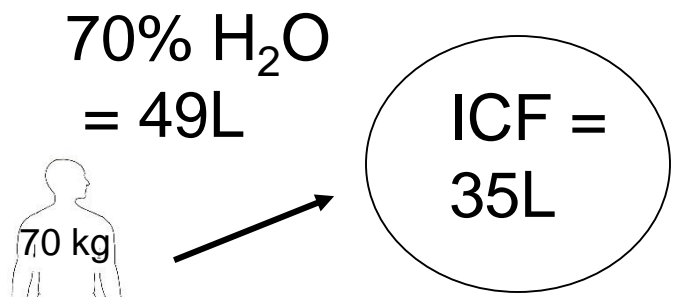

+

ECF = 14L

[Interstitium = 11L
Plasma = 3L]

INPUT

Dietary Drink	1200 mL
Dietary Eat	400 mL
Oxidation	400 mL
Total =	2000 mL

H₂O



BALANCE!

OUTPUT

Urine	1000 mL
Sweat + Insensible	900 mL
Feces	100 mL
Total =	2000 mL

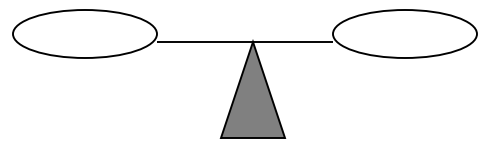

eg

Controller =
Hypothalamus
with Set Point

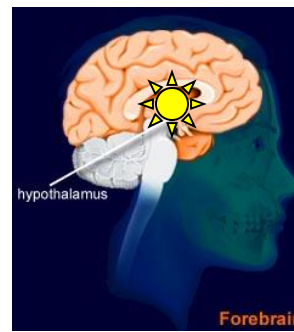

T_{bC}

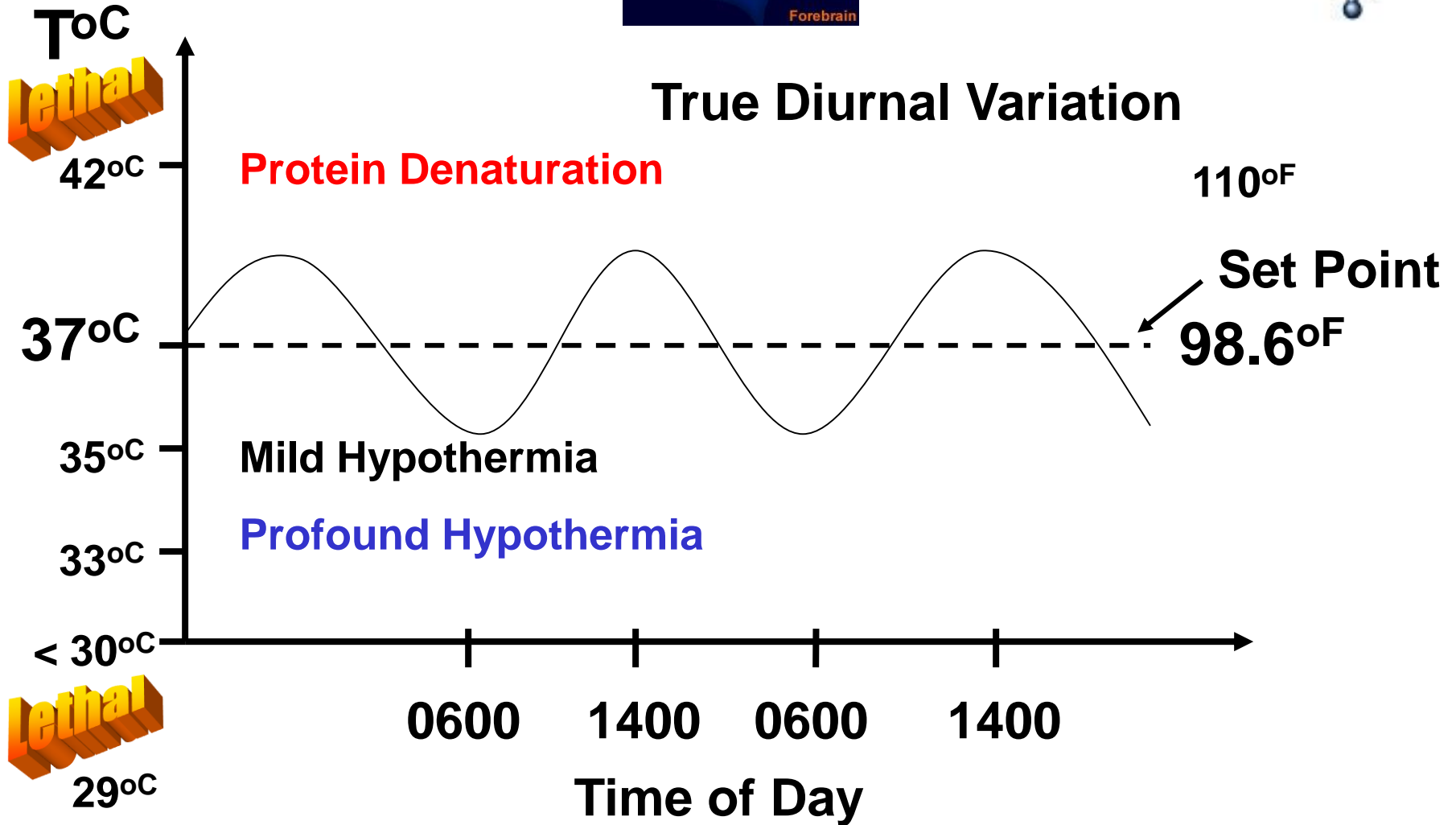
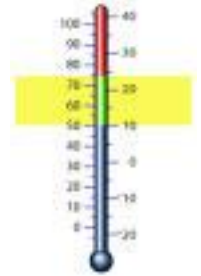

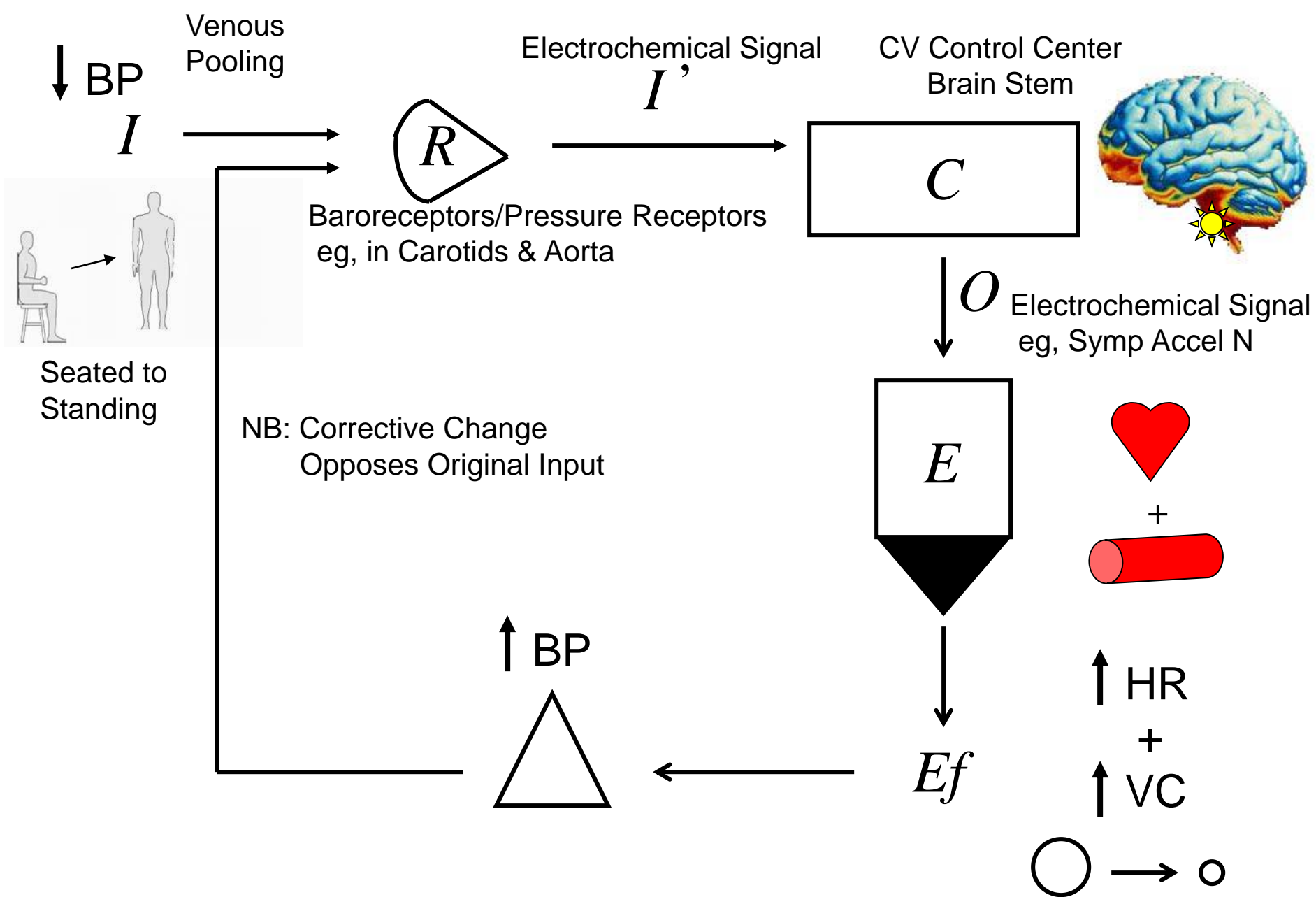

Group Discussion + Break!



HOW BIG? 100 CELLS LENGTHWISE = 1 mm!!

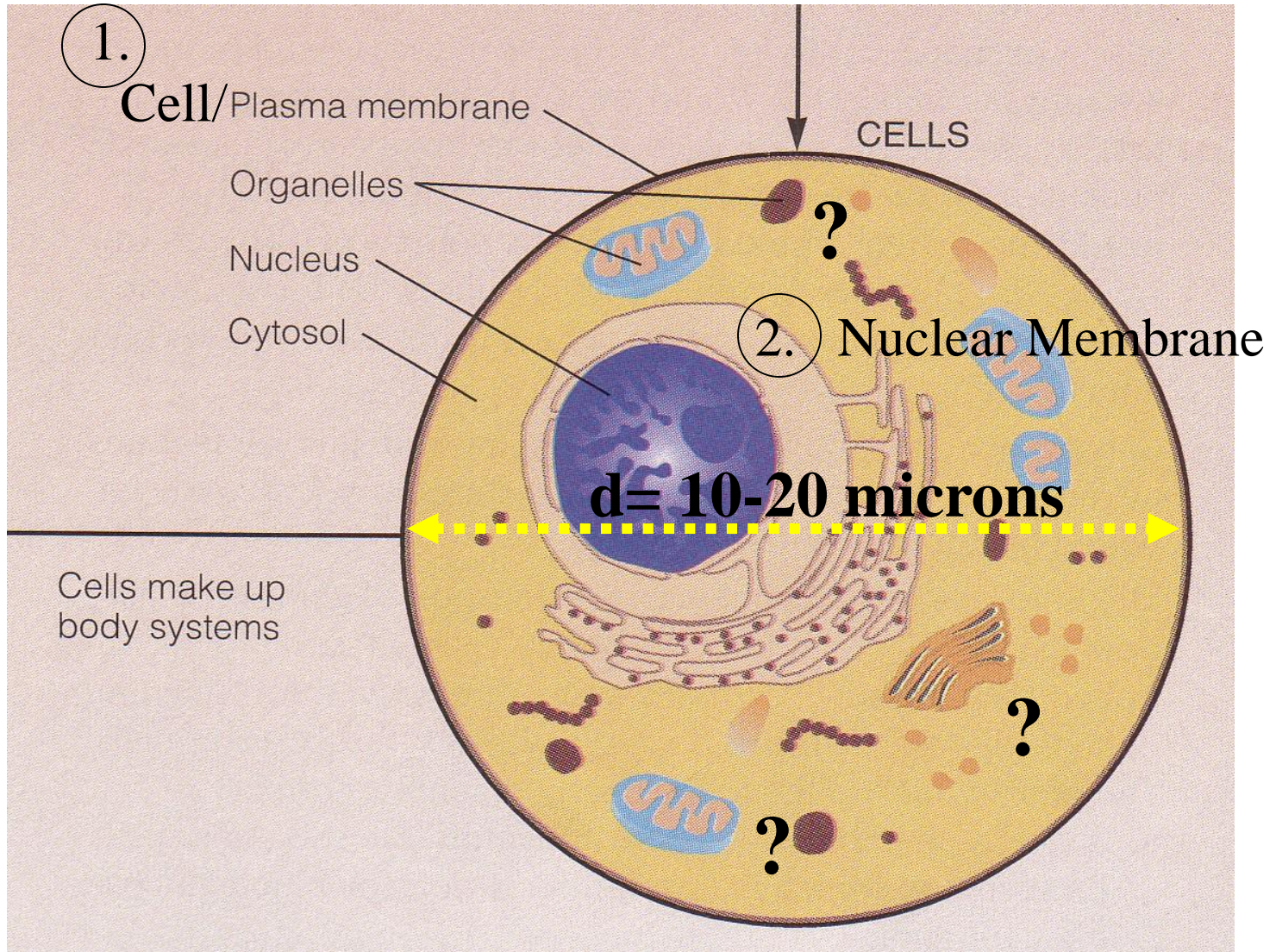

Cytoplasm = Cell - Nucleus

[Extract nucleus; includes organelles]

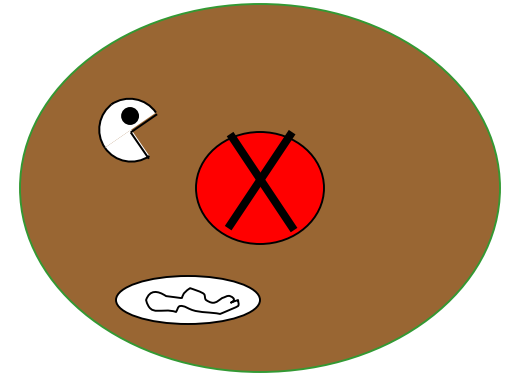

Cytosol = Cytoplasm - Organelles

[Extract organelles; complex gel-liquid]

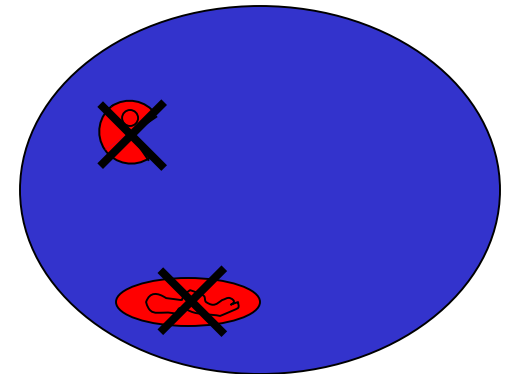

Why Compartments? Advantage?

**Incompatible reactions can
take place**

Simultaneously!!

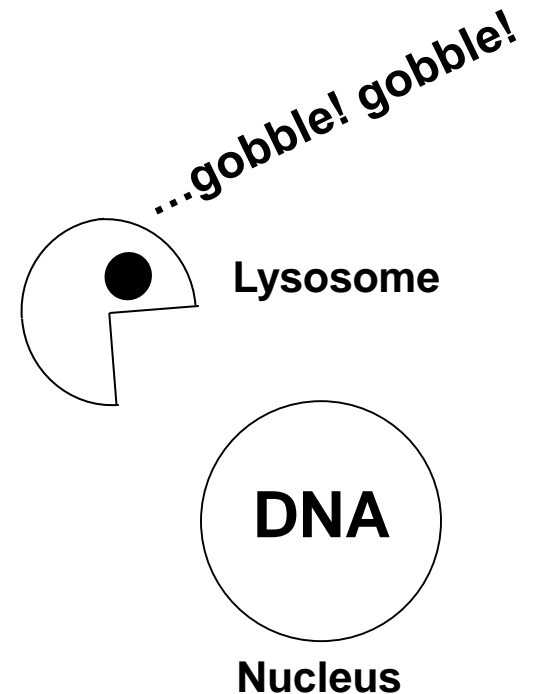

Basic Cell Survival Skills?

- 1. Get food**
- 2. Use food**
- 3. Rid wastes**
- 4. Move**
- 5. Reproduce**

Nucleus or nose?

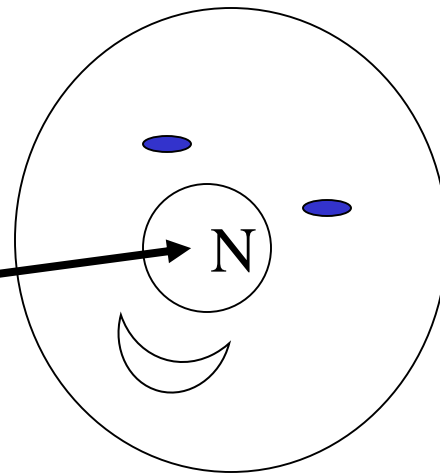

How to live?

1 e.g. Cell of 100 Trillion!

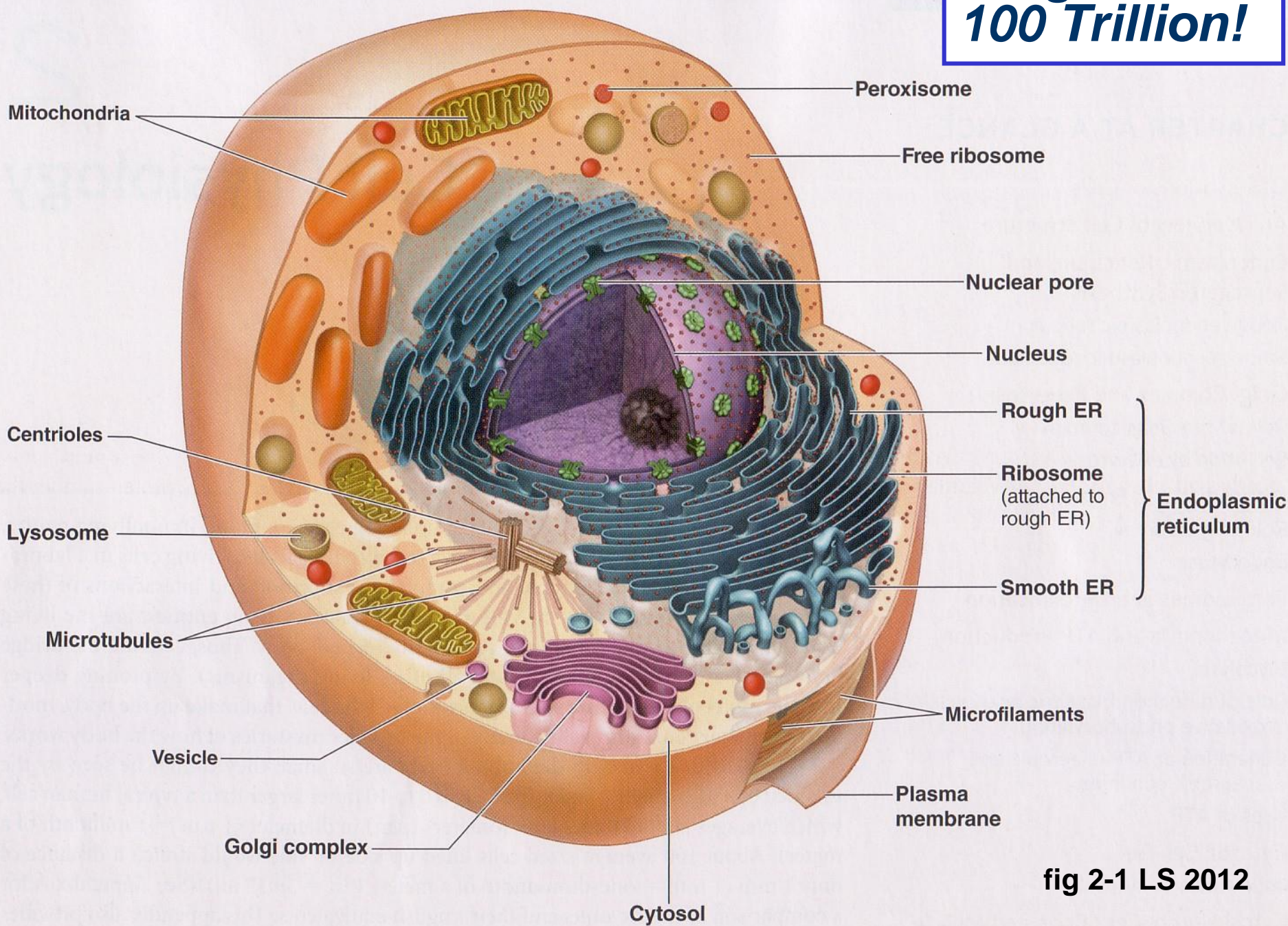

fig 2-1 LS 2012

Rough & Smooth Endoplasmic Reticulum (ER): Protein & Lipid Synthesizing Factories

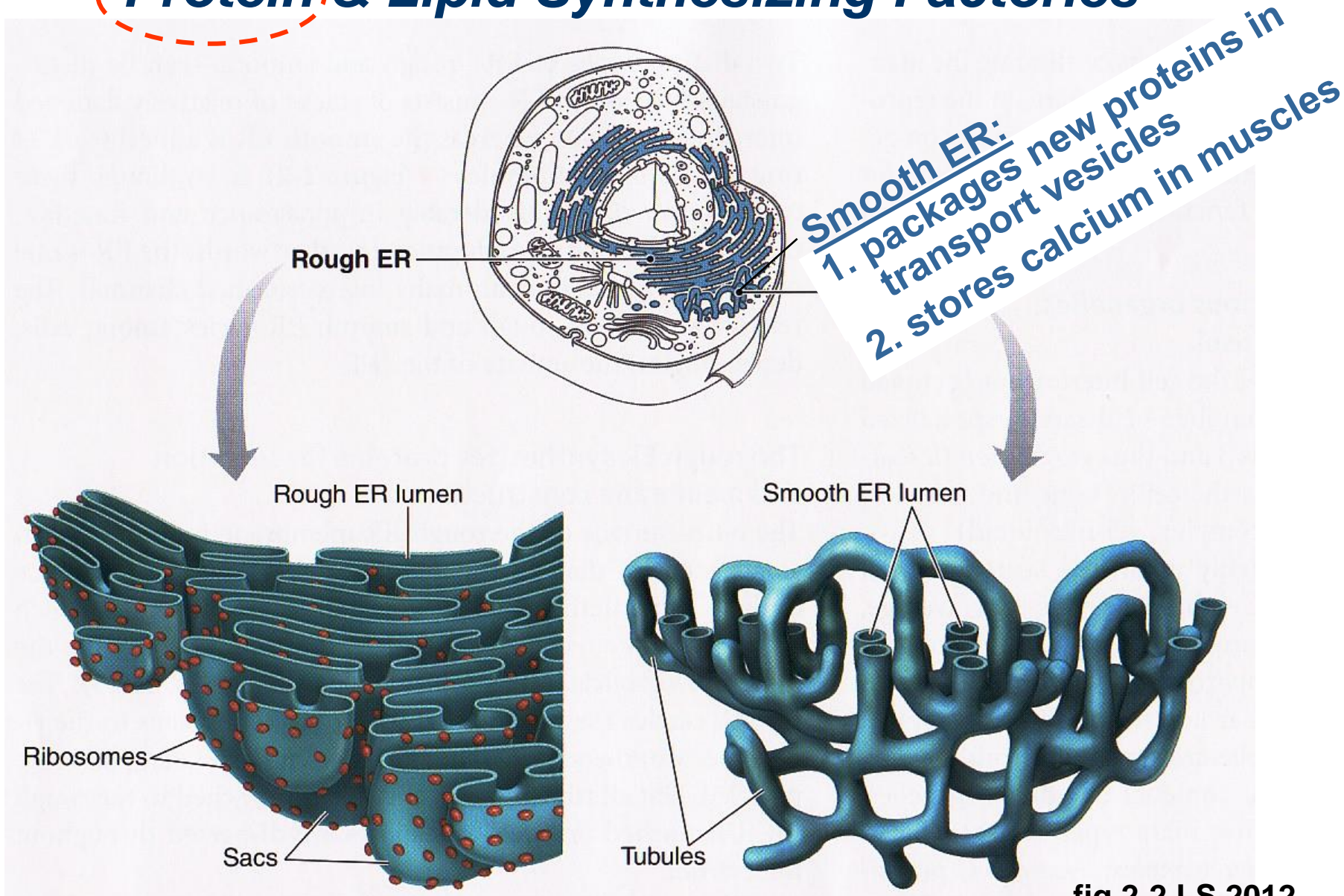
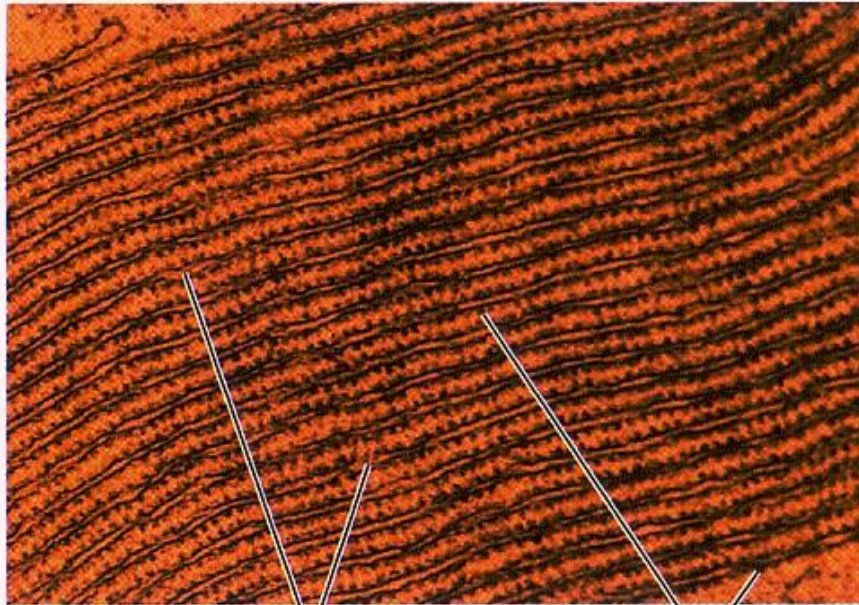

fig 2-2 LS 2012

Electron Micrographs of Rough vs. Smooth ER



Rough ER lumen

Ribosomes

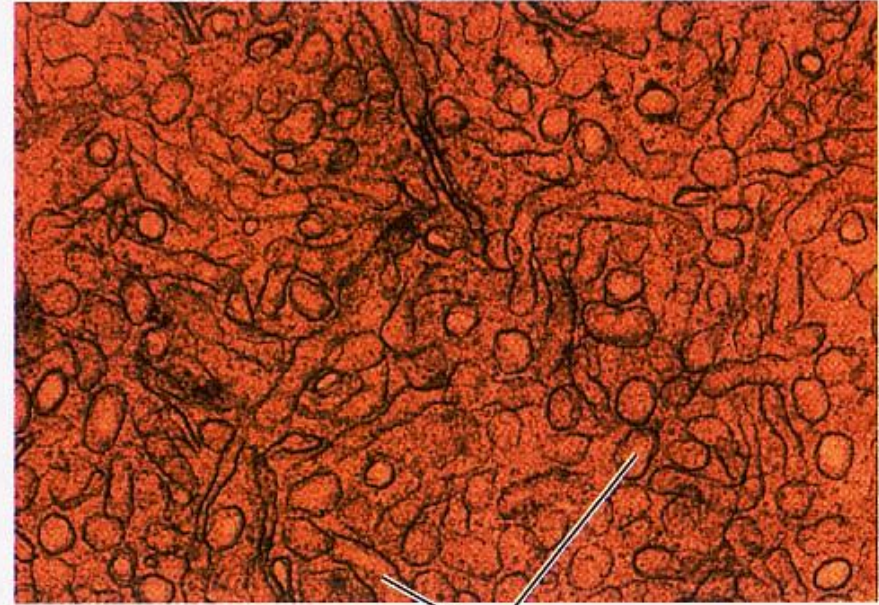

Smooth ER lumen

© Don W. Fawcett/Visuals Unlimited

Secretion of Proteins Produced by ER

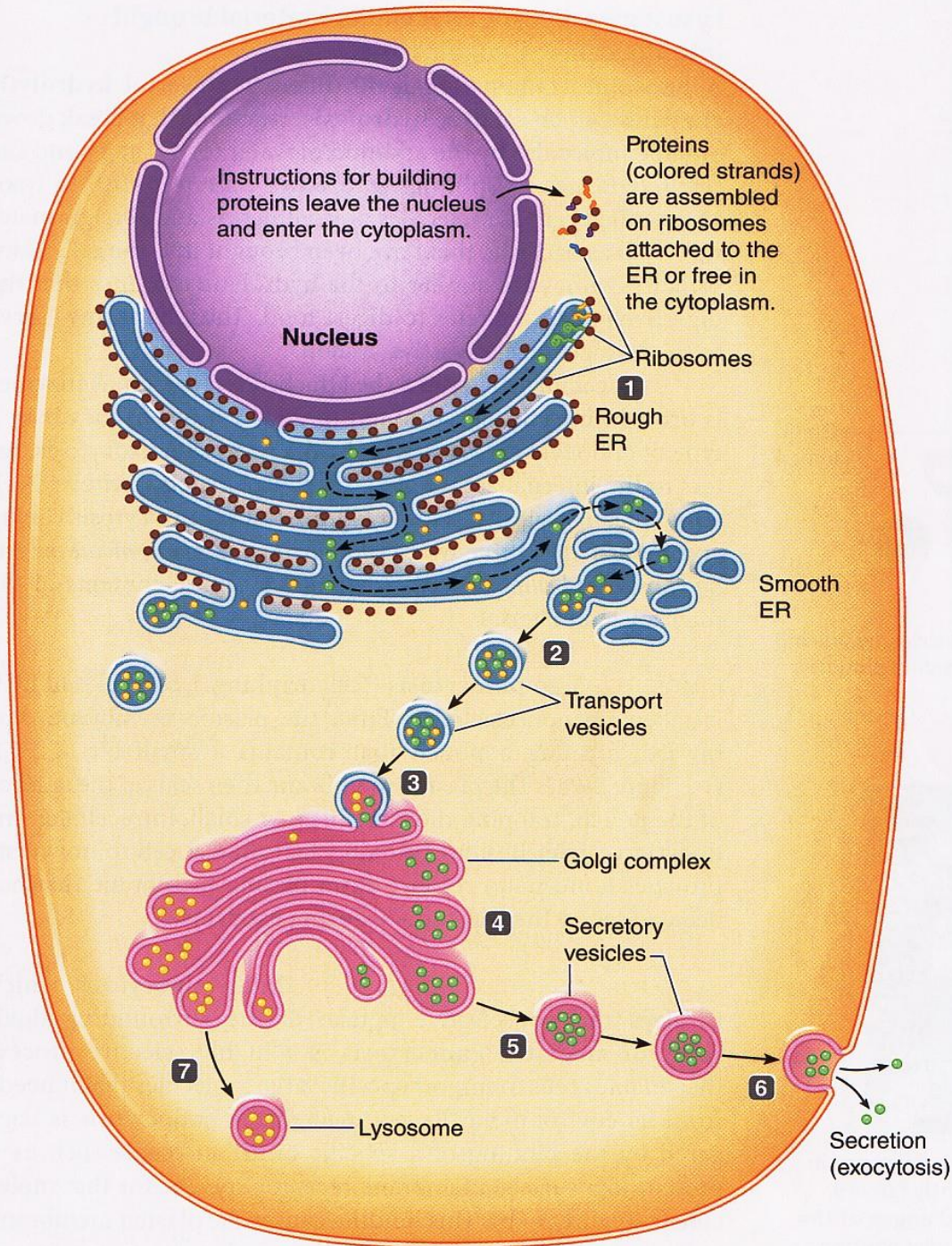
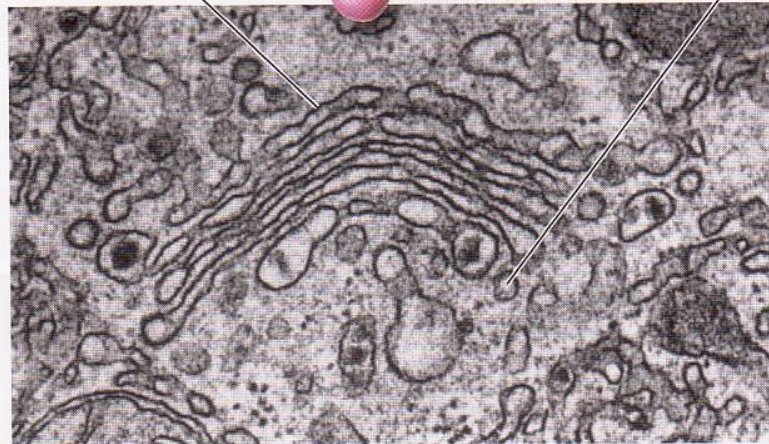
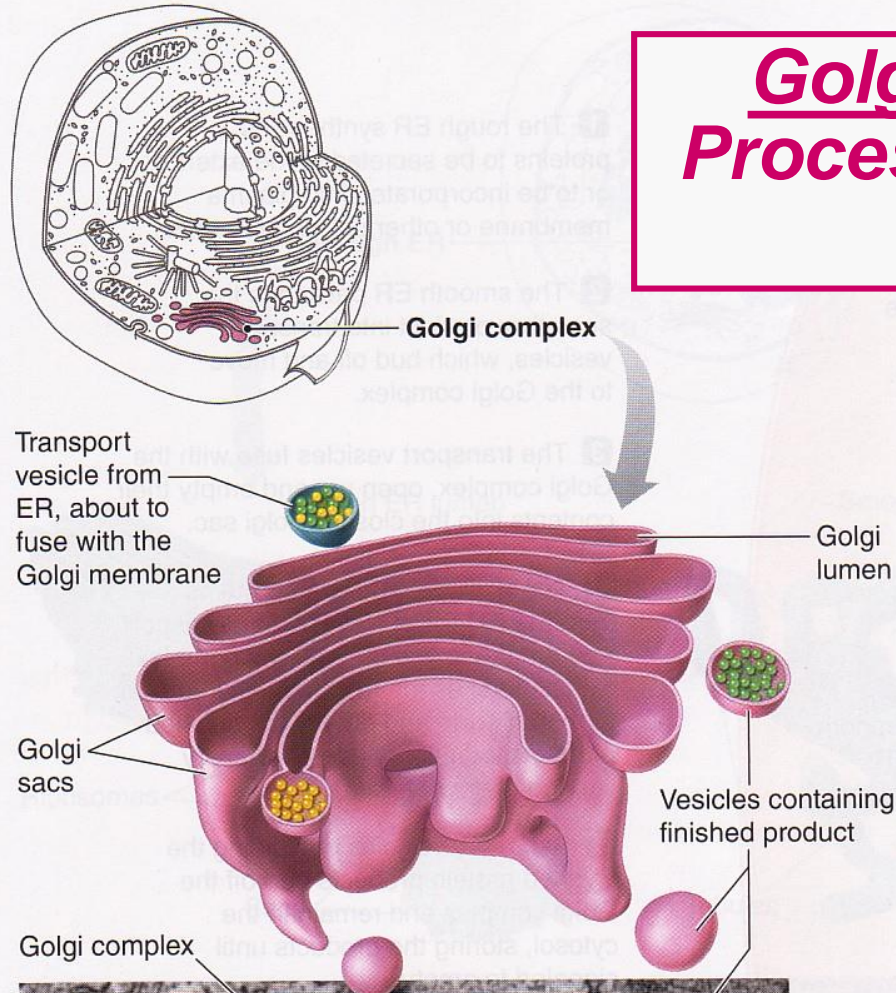

fig 2-3 LS 2012

Golgi Complex: Final Processing, Packaging & Distribution



Dr. Don Fawcett & R. Bollender/Visuals Unlimited

fig 2-4 LS 2012

Exocytosis: Primary Means of Secretion

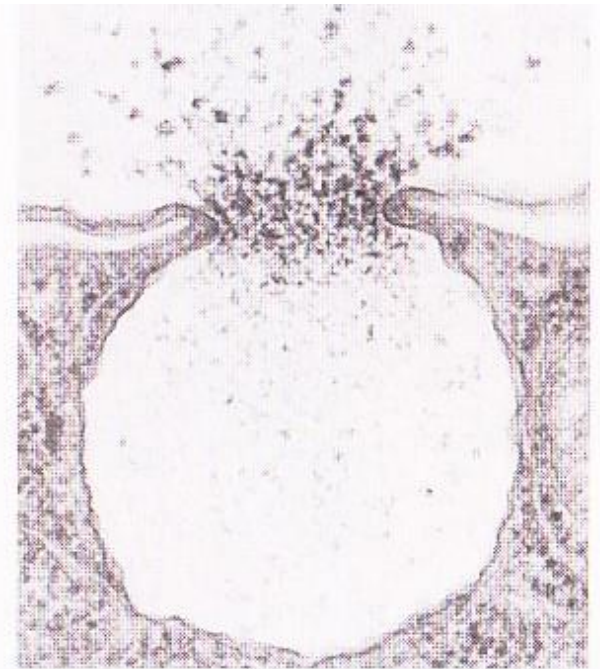
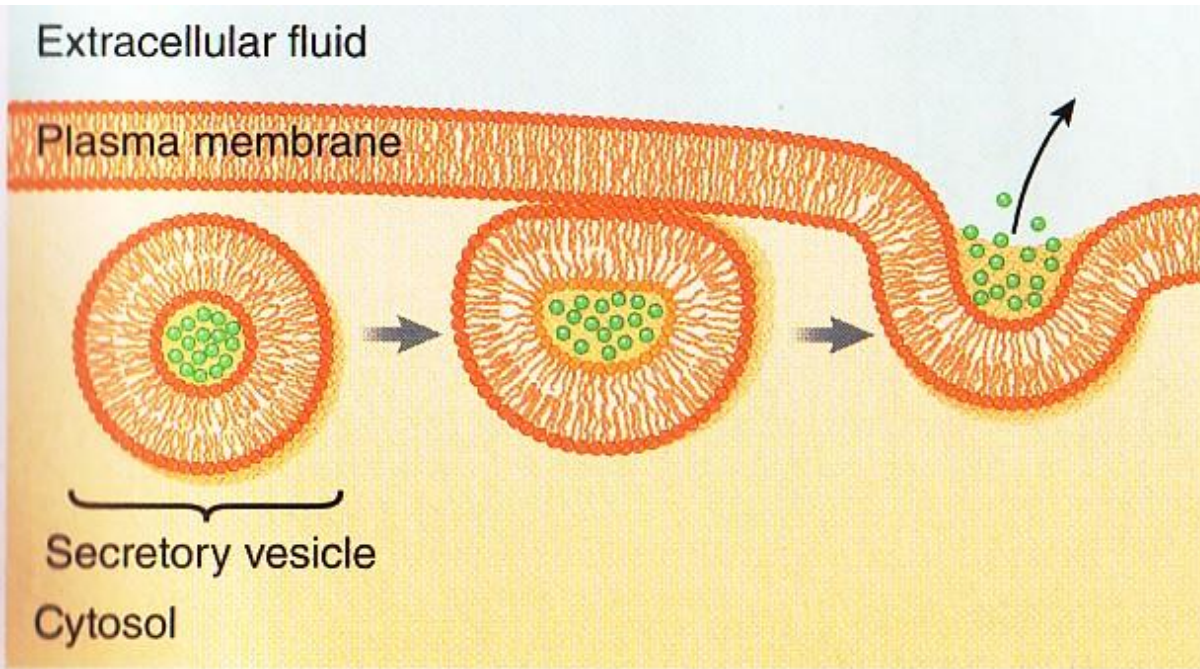

(a) Dr. Birgit Satir, Albert Einstein College of Medicine

Endocytosis: Primary Means of Ingestion

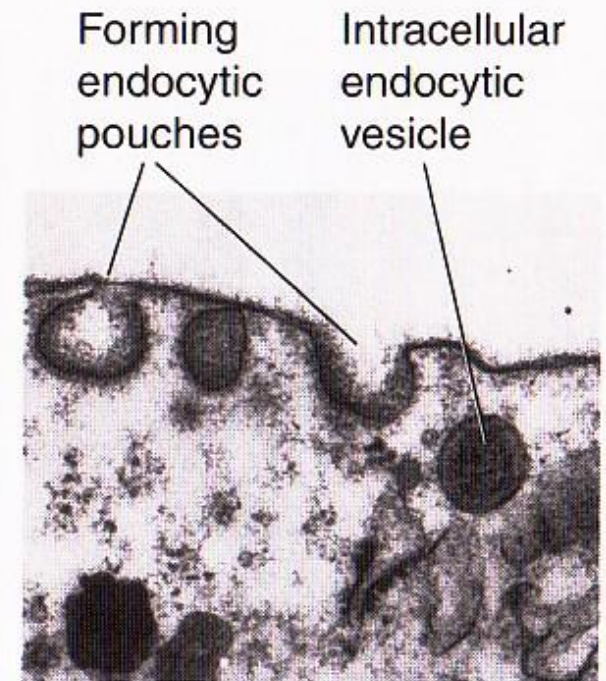
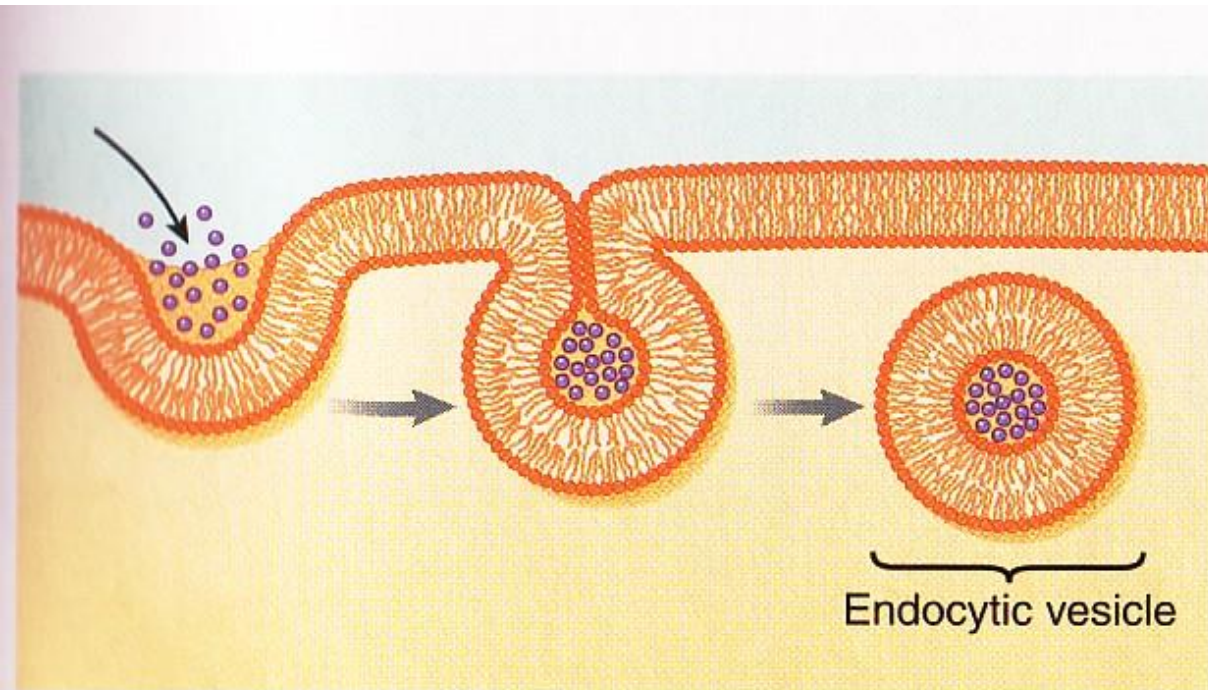

(b) © Don W. Fawcett/Photo Researchers, Inc.

Lysosomes vs. Peroxisomes

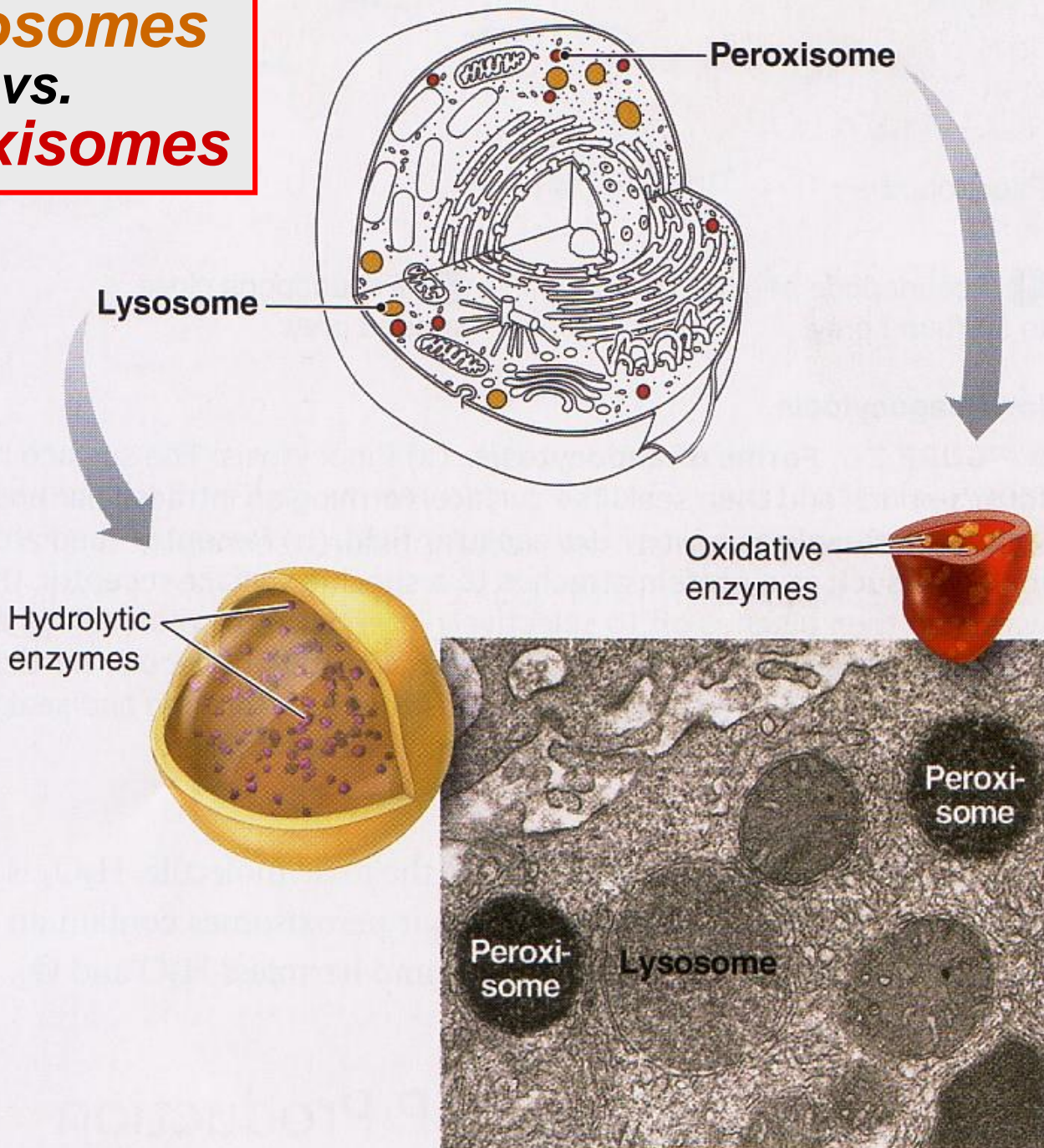

© Don W. Fawcett/Photo Researchers, Inc.

fig 2-6 LS 2012

Phagocytosis: Cell Eating!

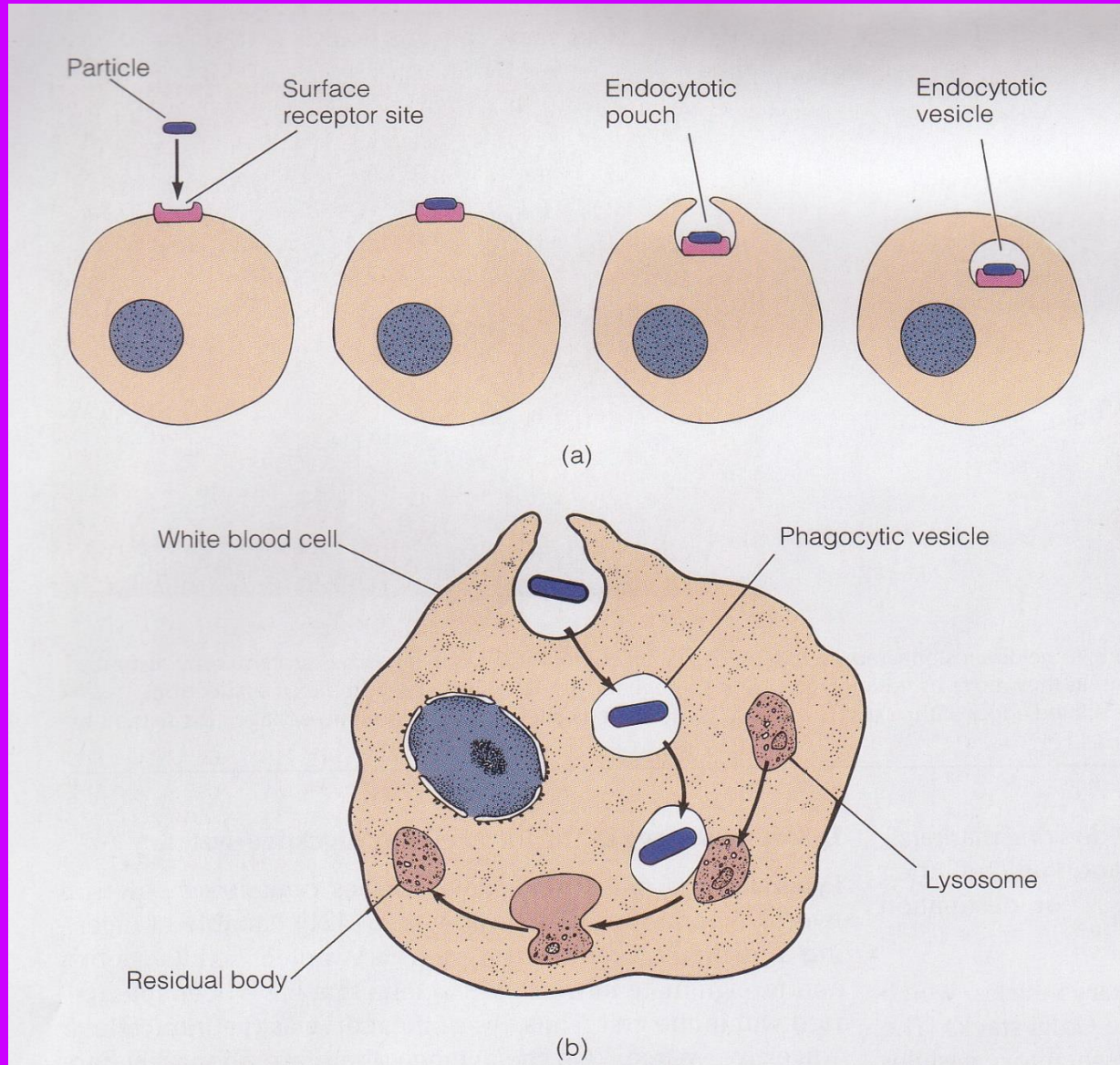

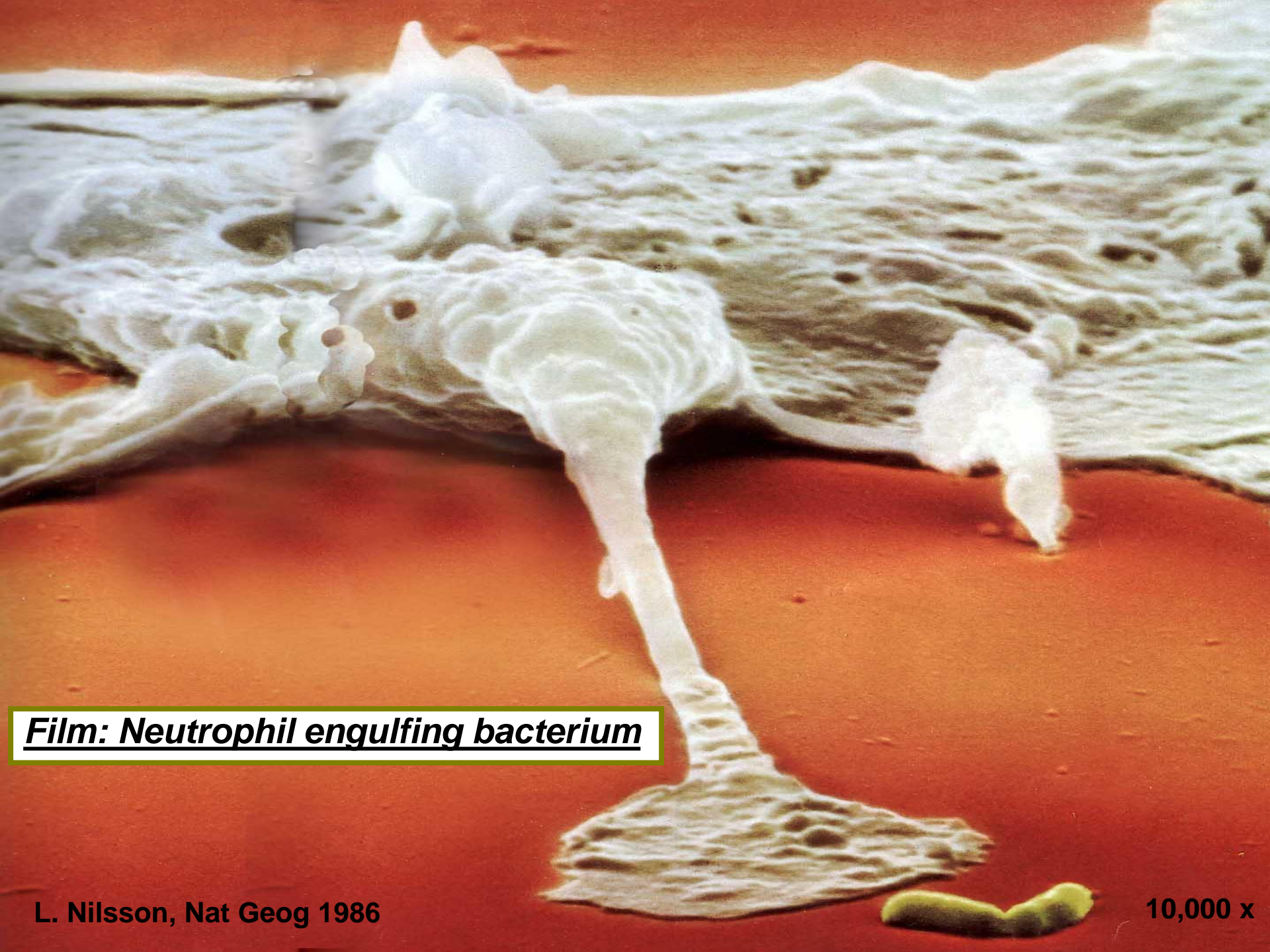

Film: Neutrophil engulfing bacterium

L. Nilsson, Nat Geog 1986

10,000 x

Catalase Enzyme Reaction in Peroxisomes Neutralize Toxin at Production Site!

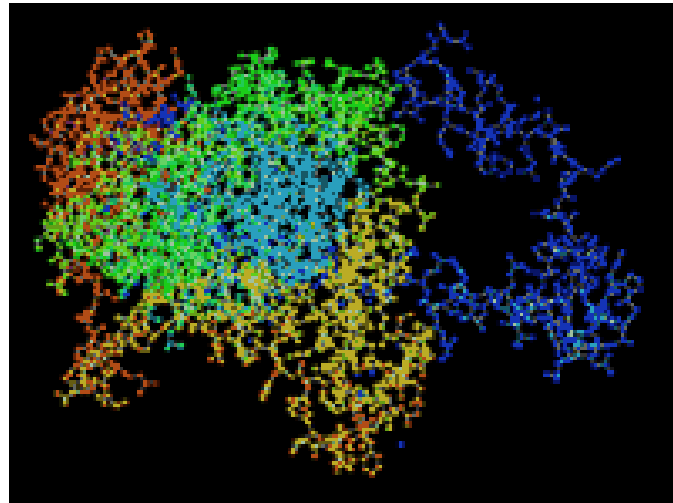

Mitochondria: Energy Organelles

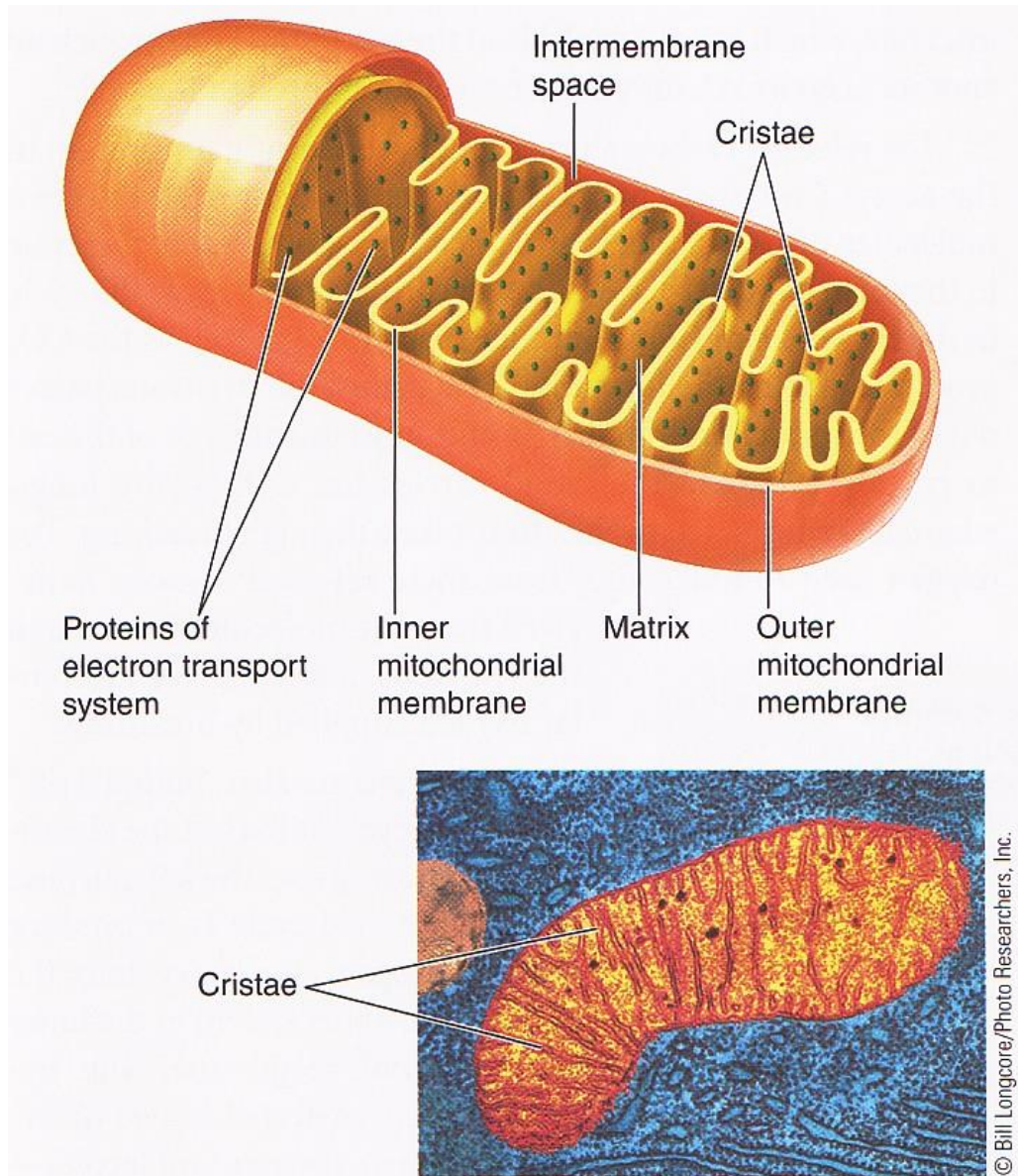
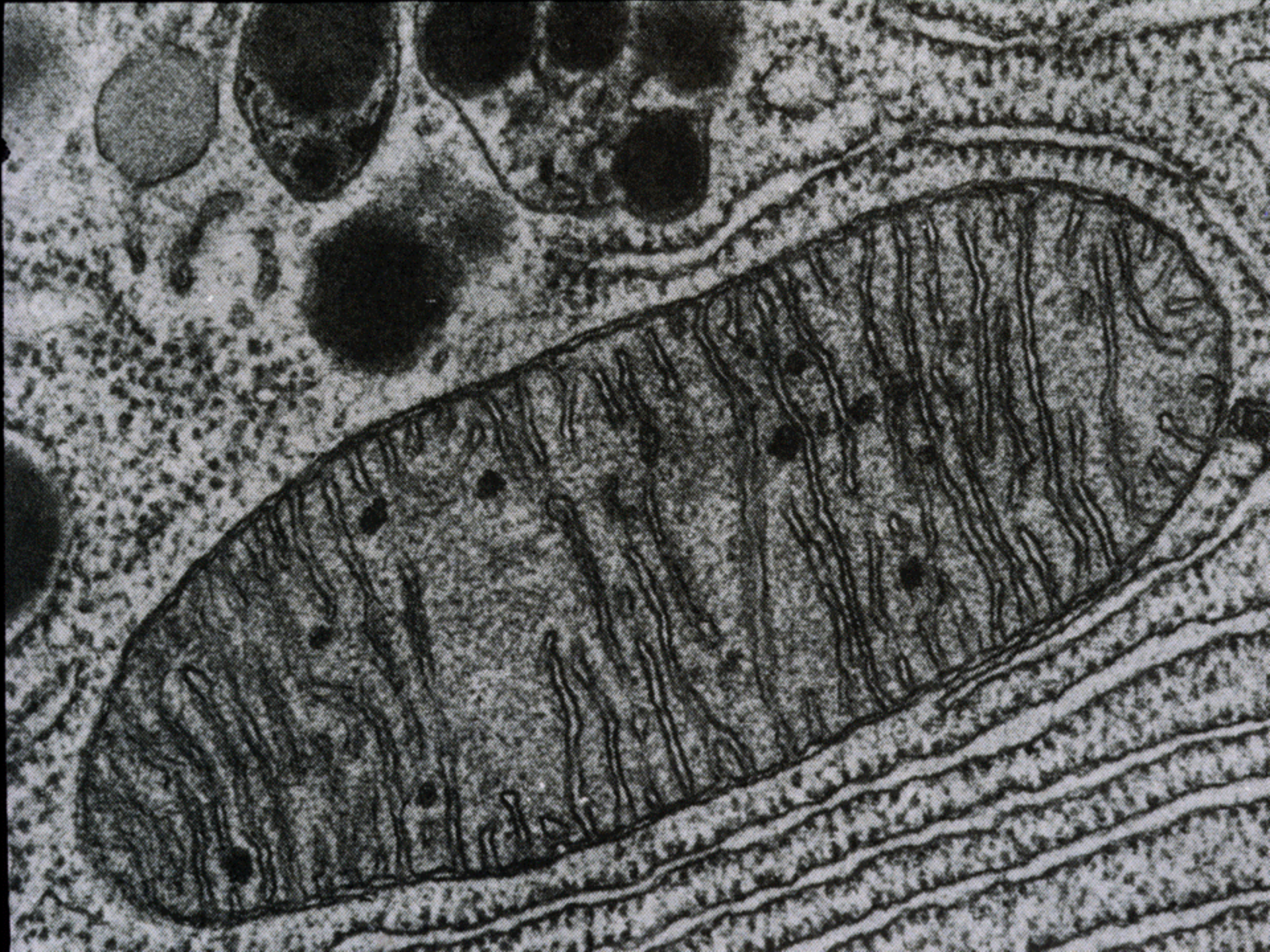
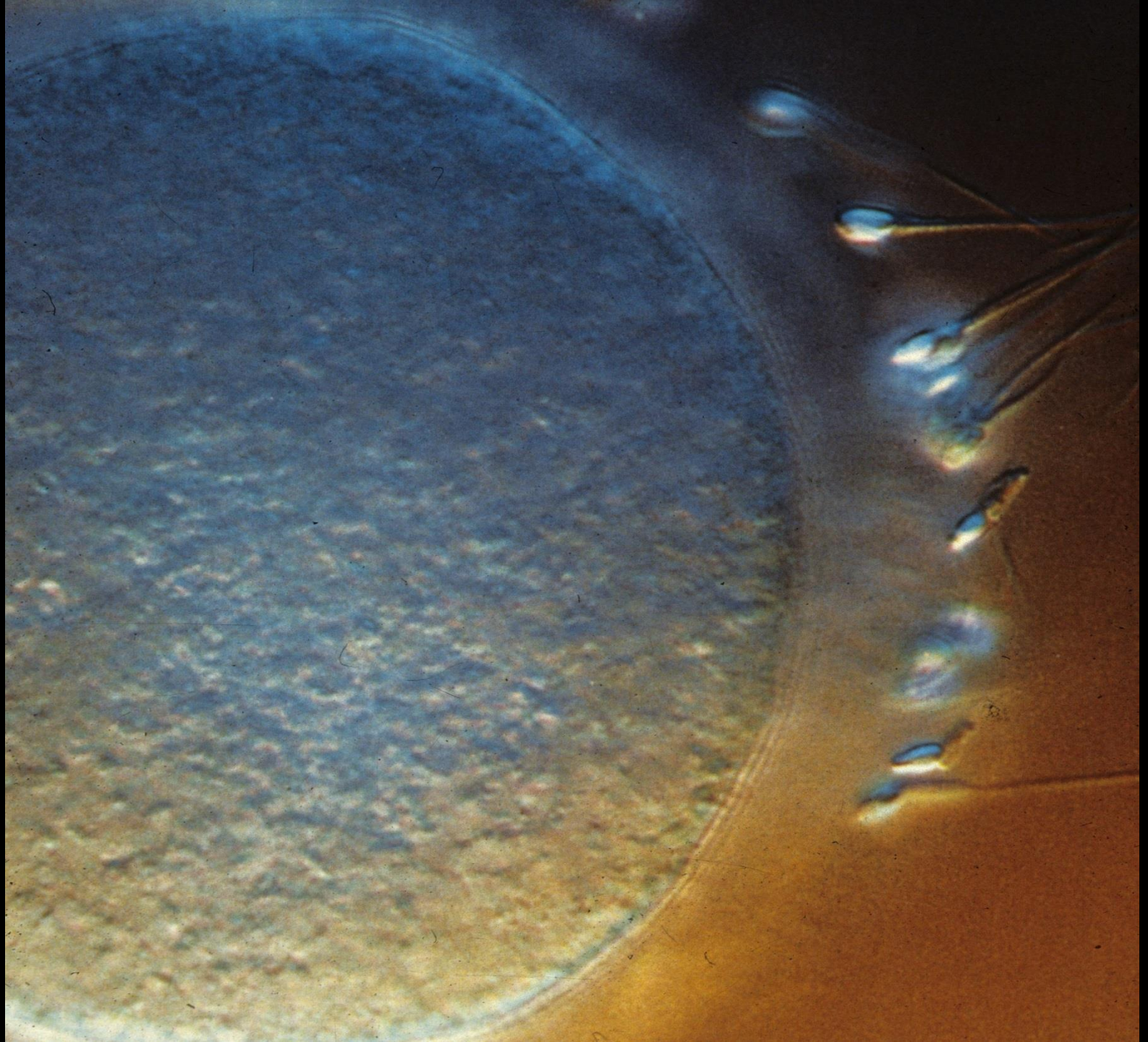

fig 2-8 LS 2012





Mom's eggs execute Dad's mitochondria

In "Hamlet," Rosencrantz and Guildenstern deliver a letter to the rulers of England that carries the ill-fated duo's own death sentence. Perhaps Shakespeare knew a bit about reproductive biology.

Scientists have now found that during a sperm's creation, its mitochondria—energy-producing units that power all cells—acquire molecular tags that mark them for destruction once the sperm fertilizes an egg. This death sentence, a protein called ubiquitin, may explain why mammals inherit the DNA within mitochondria only from their mothers, a bio-

species mitochondrial inheritance. Sperm mitochondria sometimes avoid destruction when two different species of mice mate, and Schatten's team has shown this also holds true in cattle. It's hard to understand how an egg distinguishes between paternal mitochondria of closely related species, says Schon.

When paternal mitochondria escape destruction in normal mating, the resulting embryo may suffer. Schatten notes that a colleague has found sperm mitochondria in some defective embryos from infertility clinics.



Inside a fertilized egg, with its two sets of chromosomes (**blue**), the protein ubiquitin (**red**) tags sperm mitochondria (**yellow**).

SOURCE: Sutovsky P, Moreno RD, Ramalho-Santos J, Dominko T, Simerly C, Schatten G. *Nature* 1999;402(6760), 371-2.

The Weekly Newsmagazine of Science

SCIENCE NEWS

July 27, 1996
Vol. 150, No. 4
Pages 49-64

Vaults Hold Cell Mystery

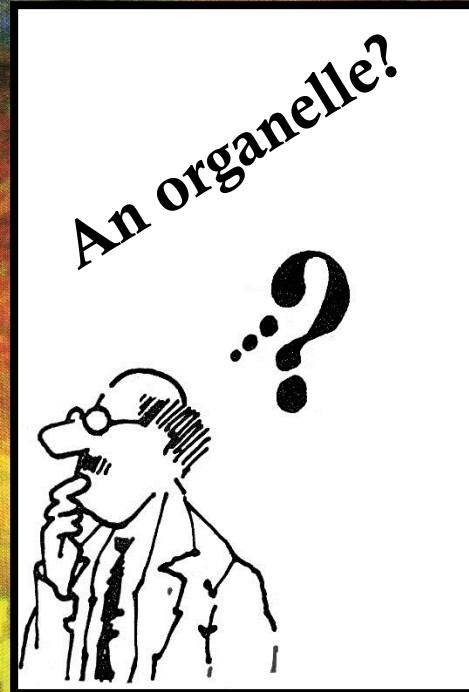

What's in the Vault?

An ignored cell component may often account for why chemotherapy fails

By JOHN TRAVIS

Can you imagine exploring the anatomy of the human body and missing the heart, the organ that sends life-giving blood coursing through the body? Of course not. Or not noticing the brain, the custodian of memories and creator of thoughts? Don't be ridiculous.

Yet cell biologists may soon have to acknowledge an equally unimaginable oversight in their field. For decades, their powerful microscopes have failed to spot a basic cell component of animals and perhaps any organism with a nucleus. Known as vaults, the barrel-shaped particles are three times the size of ribosomes, the org-

through a microscope. But if it were contaminated with objects that shrug off the stain, that sea would be dotted with white islands. Rome likens the strategy to finding an invisible person by looking for an unexplained shadow in the beam of a spotlight.

To Kedersha's surprise, unstained ovoid objects appeared among her coated vesicles. Since some of the stain settled into furrows on top of the unexpected shapes, the negative staining revealed fine details of the exterior of these mysterious interlopers, including arches that reminded Rome and Kedersha of the cell

us something by this incredible structure. And the one thing we might surmise from the structure [of vaults] is that they might contain something," says Rome.

That shape also hints that vaults may pick up their unknown cargo at the nuclear membrane, the barrier that separates the cell's cytoplasm from its nucleus. The nucleus is a fluid-filled sac containing DNA and the machinery required to translate the instructions encoded by that DNA into molecules called messenger RNA. These mRNA strands, as well as other molecules, must somehow get out of the cell.

Sharon Belkin

