



... Thanks for signing attendance roster & noting late arrival or early departure time!



## BI 121 Lecture 2

**I. Announcements** Lab 1 Histology today!  
130 HUE. Fun! Readings: DC, LS, LM? **NB**: UO Biology blog vs. Canvas <http://blogs.uoregon.edu/bi121/fall-2016/>

**II. Homeostasis** LS ch 1, DC Module 1

- A. **What?** Maintenance of ECF LS p 8
- B. **Where?** ECF = Plasma + Interstitium + ? LS fig 1-4 p 8
- C. **Homeostatic Balances?** LS p 9, DC pp 5-6
- D. **Why?** Cell survival! LS fig 1-5 p 9, DC p 5
- E. **Physiology in the News** H<sub>2</sub>O? Are we like watermelons?
- F. **How** are balances maintained? Simplified Homeostatic Model cf: LS fig 1-7 p 14; T°C + BP balance e.g. + vs. - FB

**III. Cell Anatomy, Physiology & Compartmentalization** LS ch 2

- A. How big? What boundaries? Why compartments? pp 19-21
- B. Basic survival skills LS ch 1 p 3
- C. Organelles ≡ Intracellular specialty shops  
Endoplasmic Reticulum (ER), Golgi, Lysosomes,  
Peroxisomes & Mitochondria, LS fig 2-1, 2-2, 2-3 pp 20-3

***Maintenance of a relative constancy in the  
Internal environment = ECF = fluid outside of cells***

**milieu  
interieur?**



**Claude Bernard**

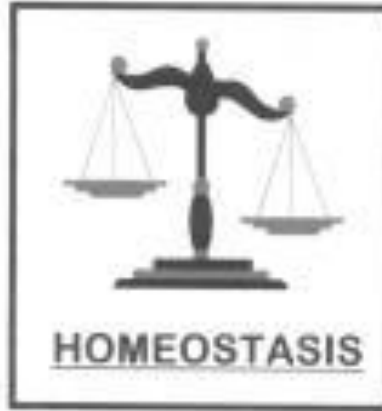

**100 trillion  
cells working  
intimately**



**Walter B. Cannon**

# Where is extracellular fluid?

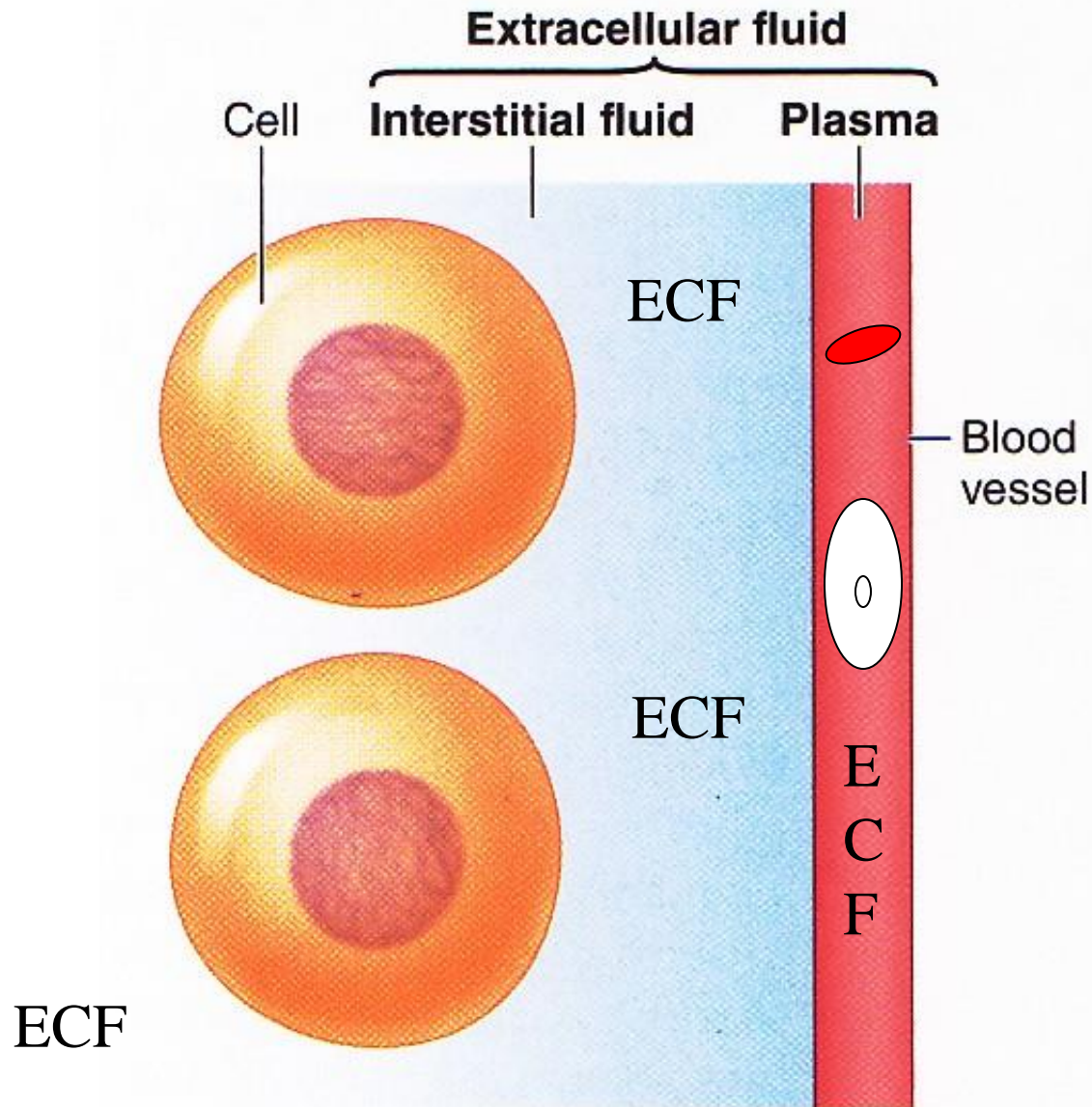

# Where is extracellular fluid?

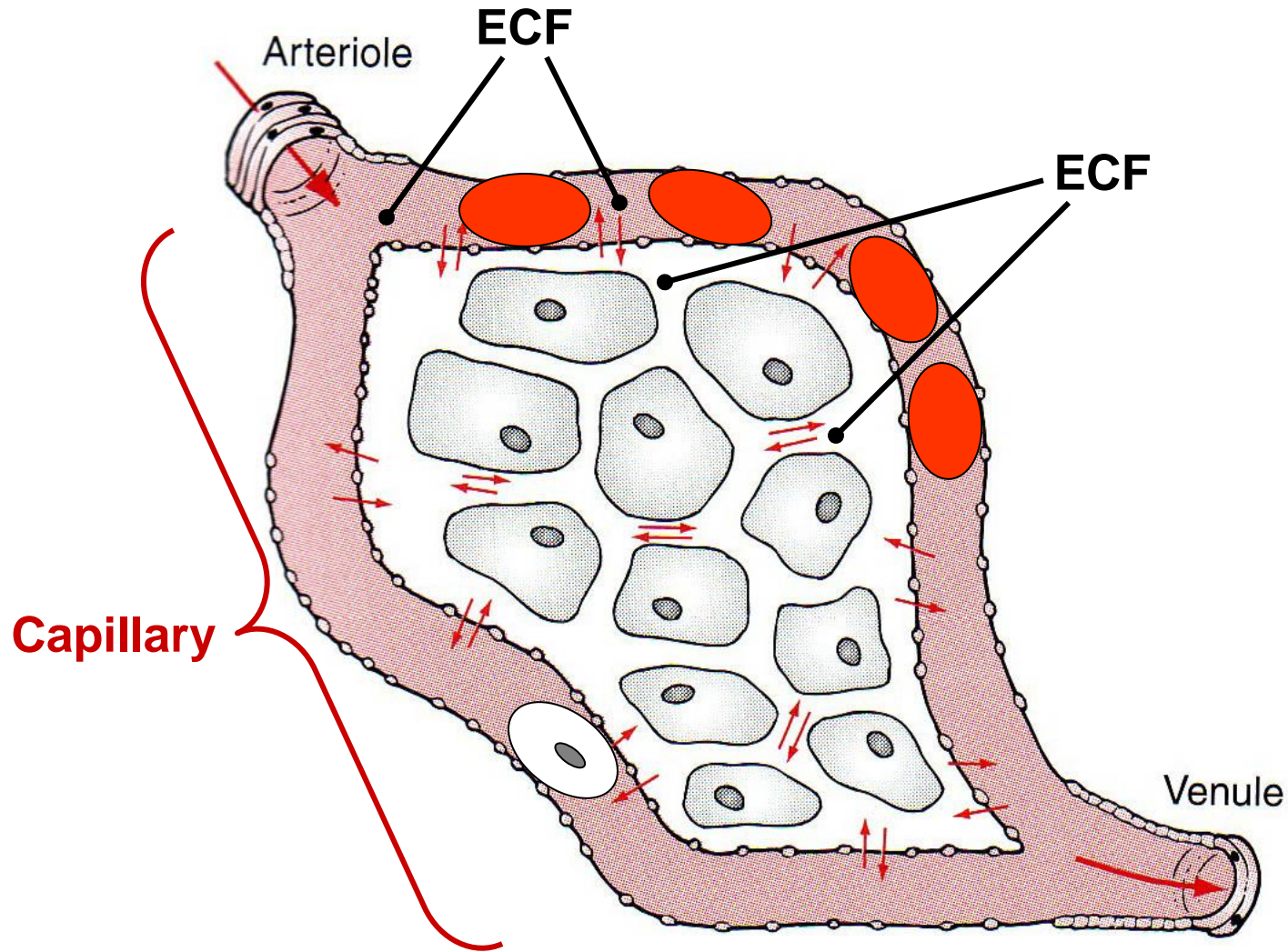

As long as between/outside cells, **ECF everywhere?**

**ECF = Extracellular**

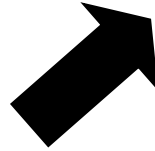

**Plasma**   
(within CV System)

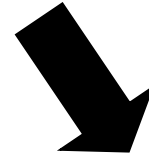

**Interstitium**  
(eg, between  
muscle cells)

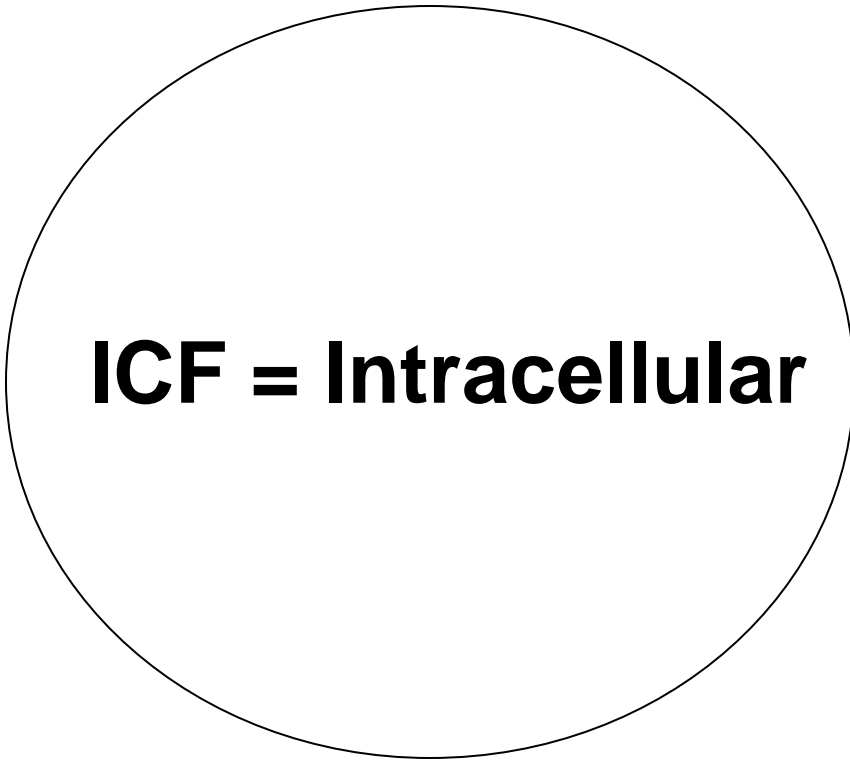

**ICF = Intracellular**



HOMEOKINESIS?



# Metabolic

ANA-

CATA-

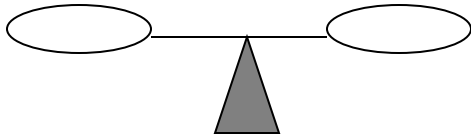

# H<sub>2</sub>O



# T<sub>o</sub>C



## Dr. Evonuk's 6 Balances

# O<sub>2</sub>/CO<sub>2</sub>

Carbon Dioxide

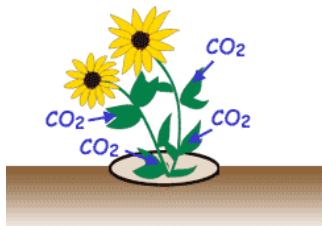

# Ion<sup>+/-</sup>



Captain Calcium



# pH

Bicarbonate and pH Balance

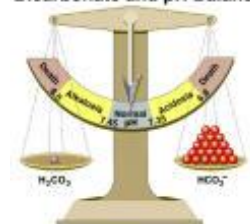

No, we're not watermelons,  
but H<sub>2</sub>O is definitely critical!!

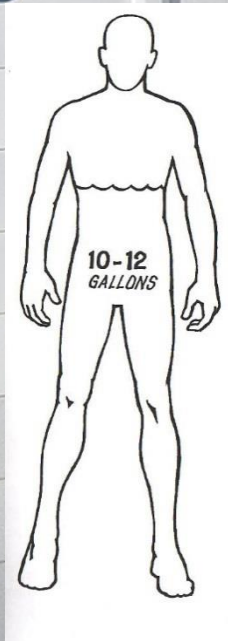

≠



because  
you're 98%  
water.





**Drink about 1 L per 1000 calories energy expenditure!!**

**Human ~ 2/3 H<sub>2</sub>O**  
**~ 60 – 70 %**

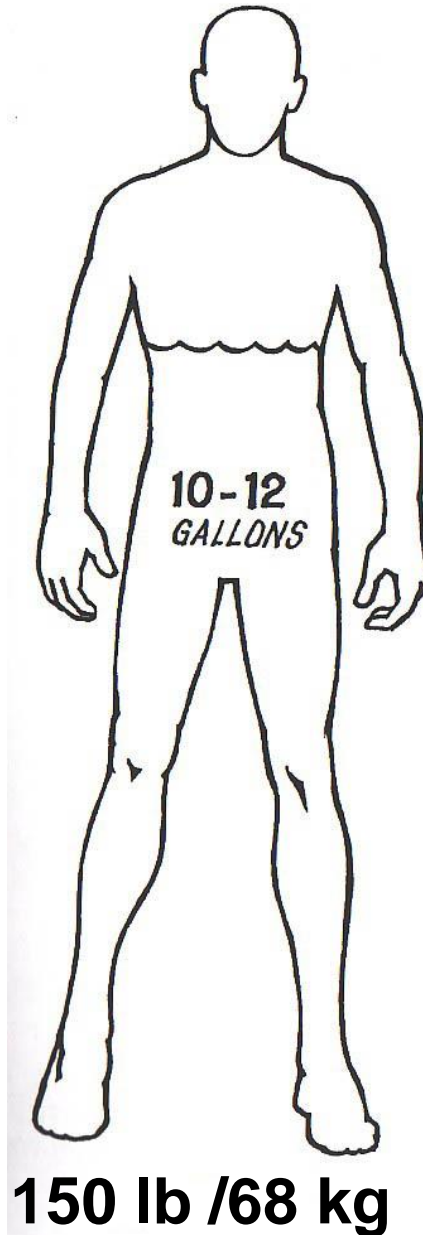

**NB: So 2000 kcal →**  
**drink 2000 mL**  
**≡ 67.63 fl oz**  
**≡ ~ 8 cups!**

**= ~40 – 48 kg H<sub>2</sub>O**

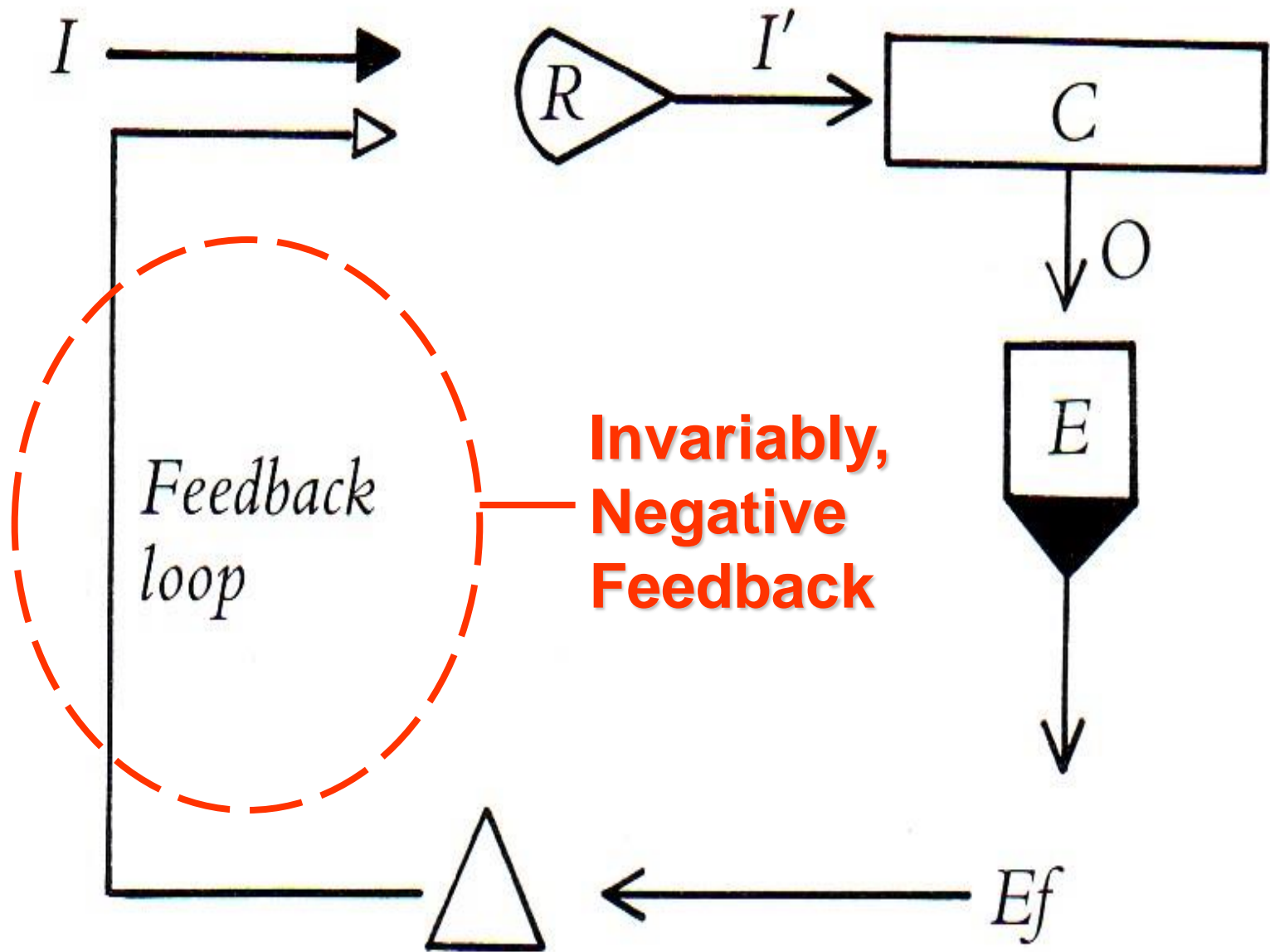

**NB:** Though most often **negative** feedback, there are exceptions:

**Selected +FB eg:**

**LH Surge + Ovulation**

**Oxytocin + Uterine Contraction**

**Blood Clotting Cascade**

**cAMP Cascade**

**Na<sup>+</sup> influx during AP**

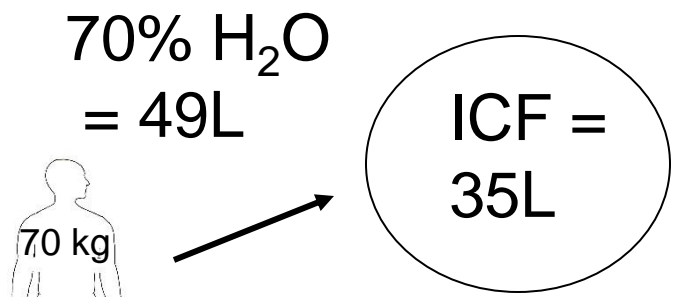

+

ECF = 14L

[ Interstitium = 11L  
Plasma = 3L ]

INPUT

Dietary Drink	1200 mL
Dietary Eat	400 mL
Oxidation	400 mL
Total	= 2000 mL ✓

H<sub>2</sub>O



BALANCE!

OUTPUT

Urine	1000 mL
Sweat + Insensible	900 mL
Feces	100 mL
Total	= 2000 mL ✓

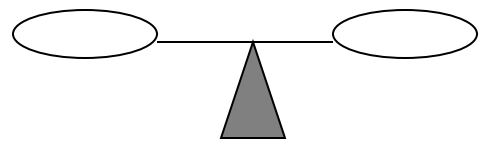



Controller =  
Hypothalamus  
with Set Point

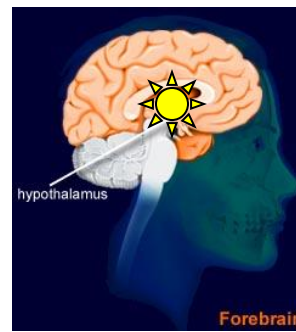

$T_{\text{bC}}$

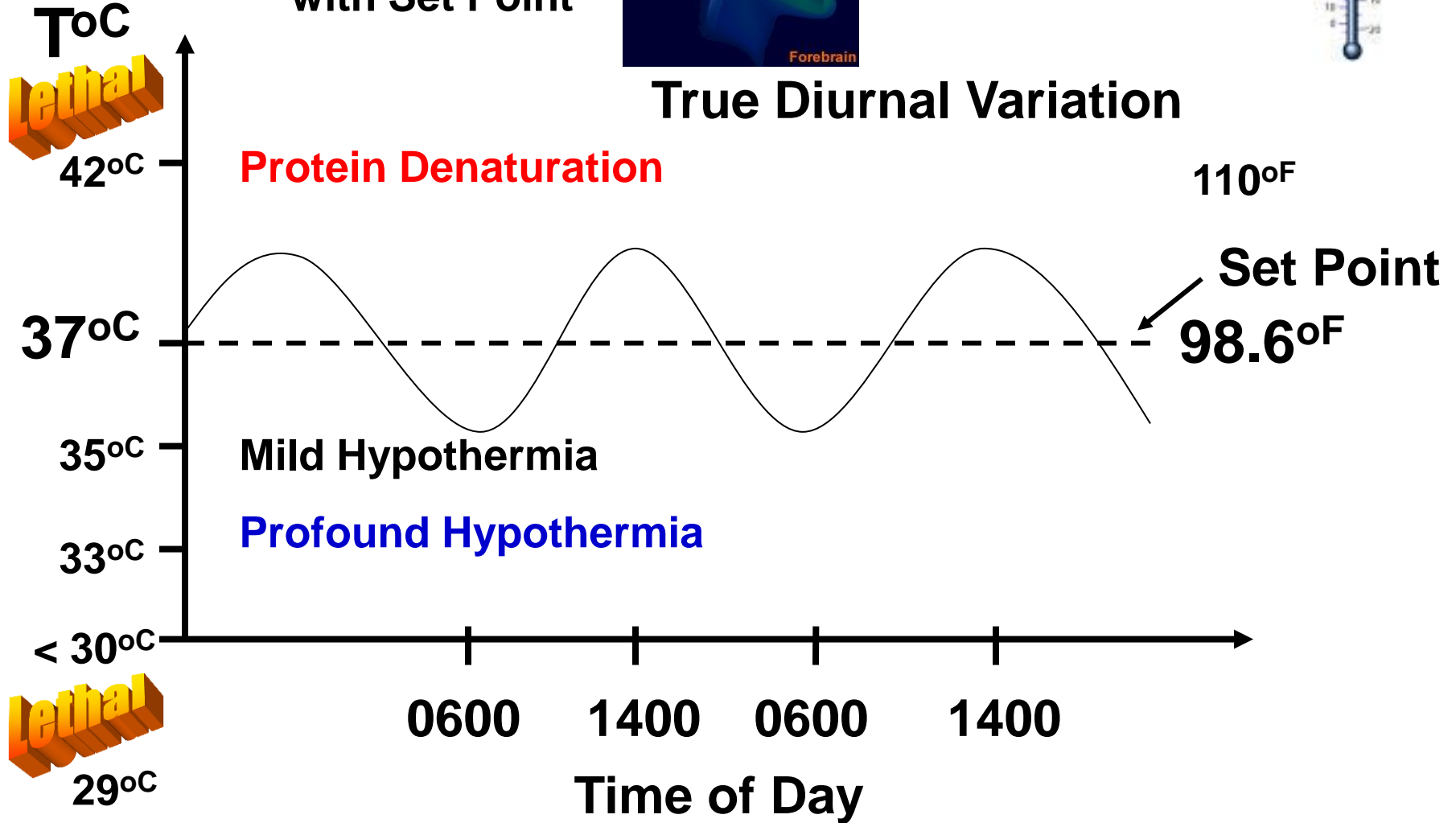
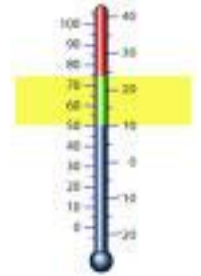

<https://www.khanacademy.org/partner-content/mit-k12/chem-and-bio/v/homeostasis>

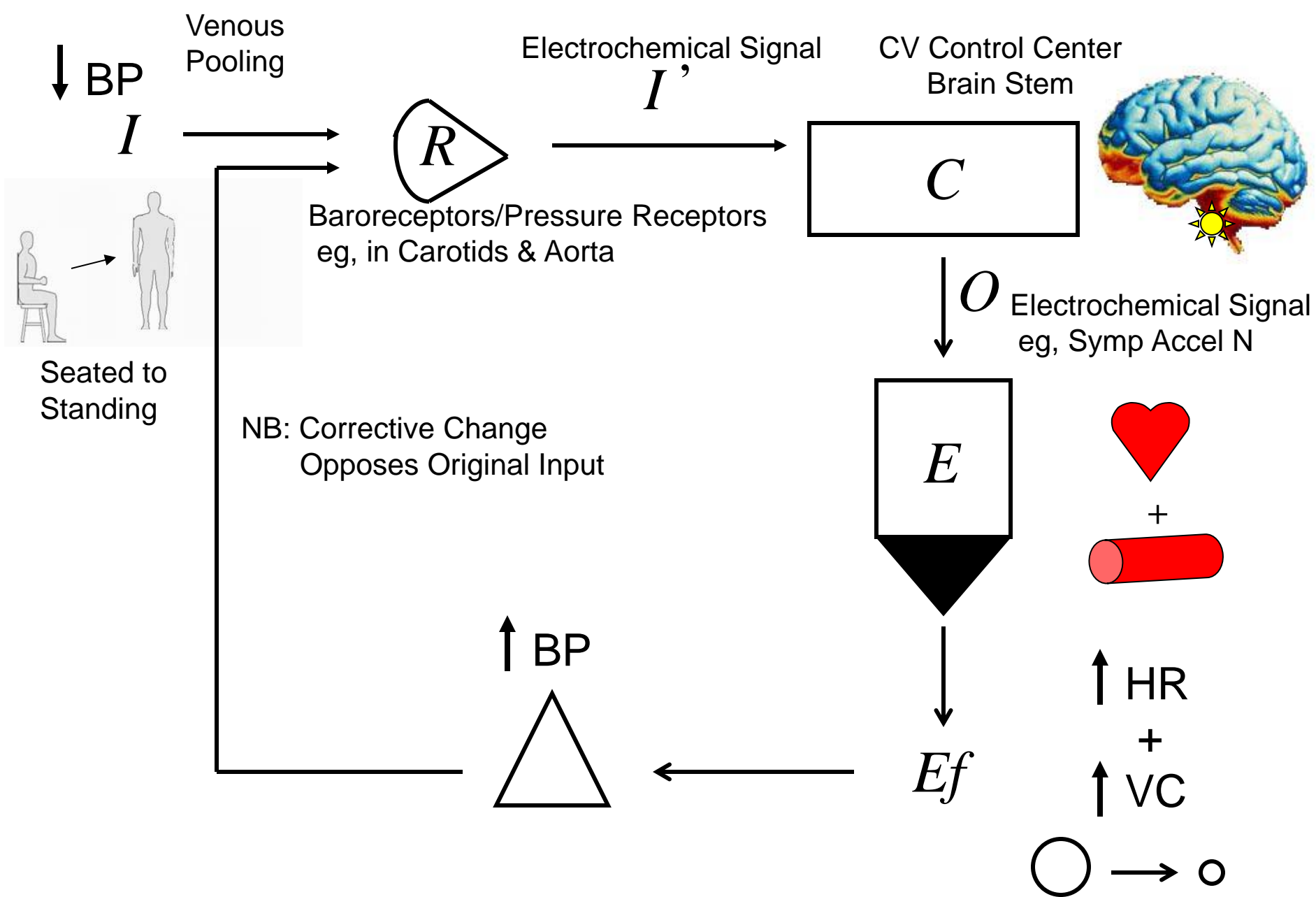

# *Class Discussion + Break!*





# HOW BIG? 100 CELLS LENGTHWISE = 1 mm!!

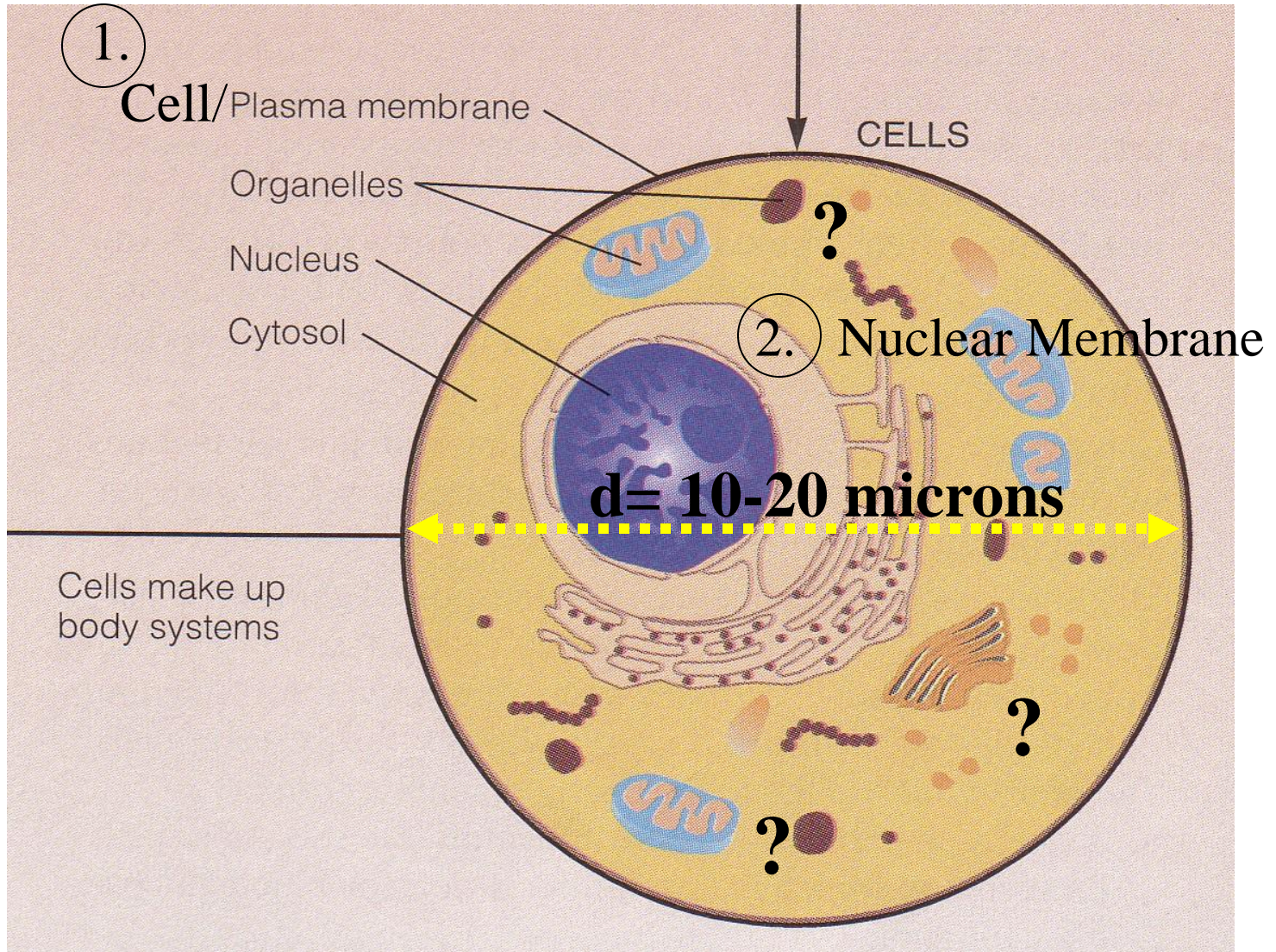



**Cytoplasm = Cell - Nucleus**

[Extract nucleus; includes organelles]

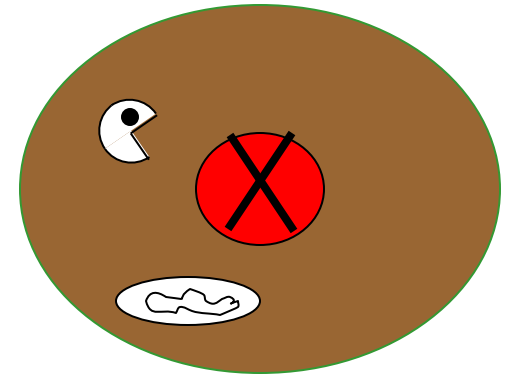

**Cytosol = Cytoplasm - Organelles**

[Extract organelles; complex gel-liquid]

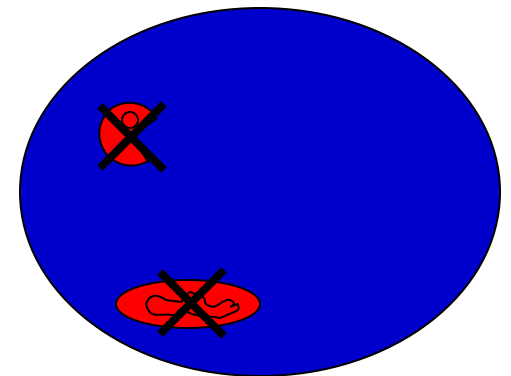

# Why Compartments? Advantage?

**Incompatible reactions can  
take place**

**Simultaneously!!**

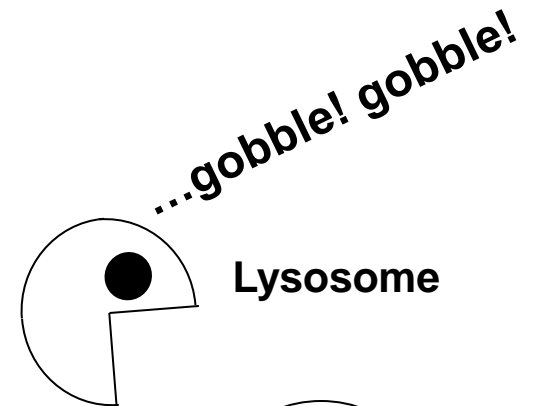

Lysosome

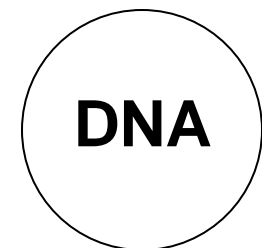

Nucleus

# ***Basic Cell Survival Skills?***

- 1. Get food**
- 2. Use food**
- 3. Rid wastes**
- 4. Move**
- 5. Reproduce**

Nucleus or nose?

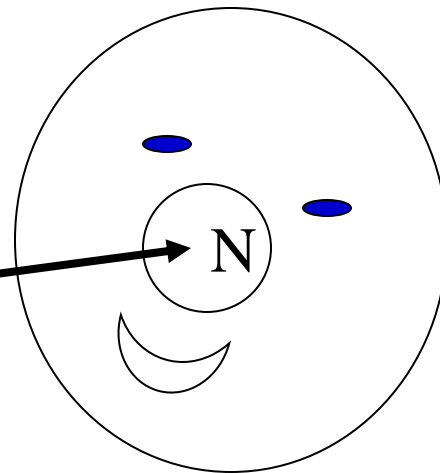

How to live?

# 1 e.g. Cell of 100 Trillion!

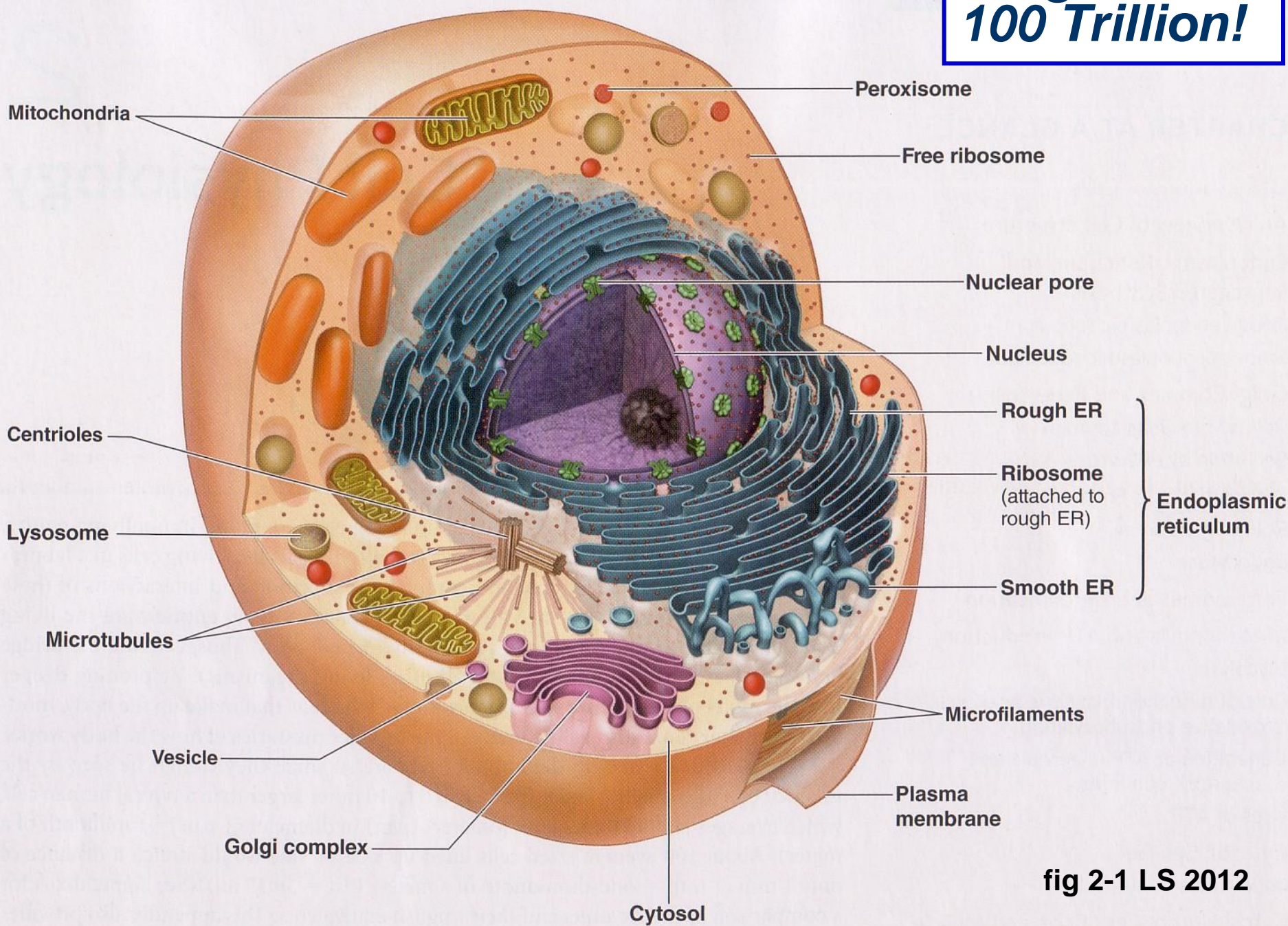

fig 2-1 LS 2012



# Rough & Smooth Endoplasmic Reticulum (ER): Protein & Lipid Synthesizing Factories

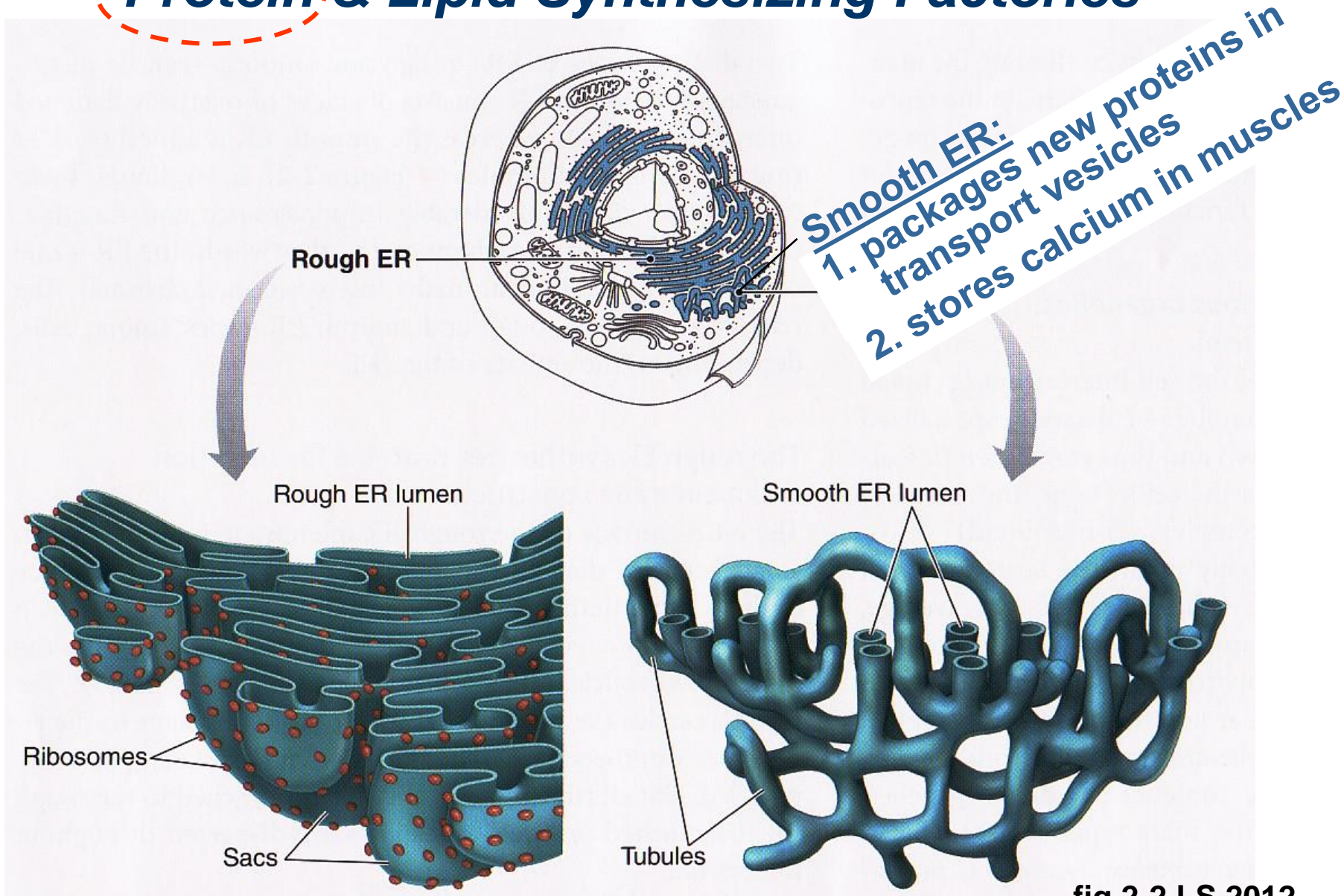
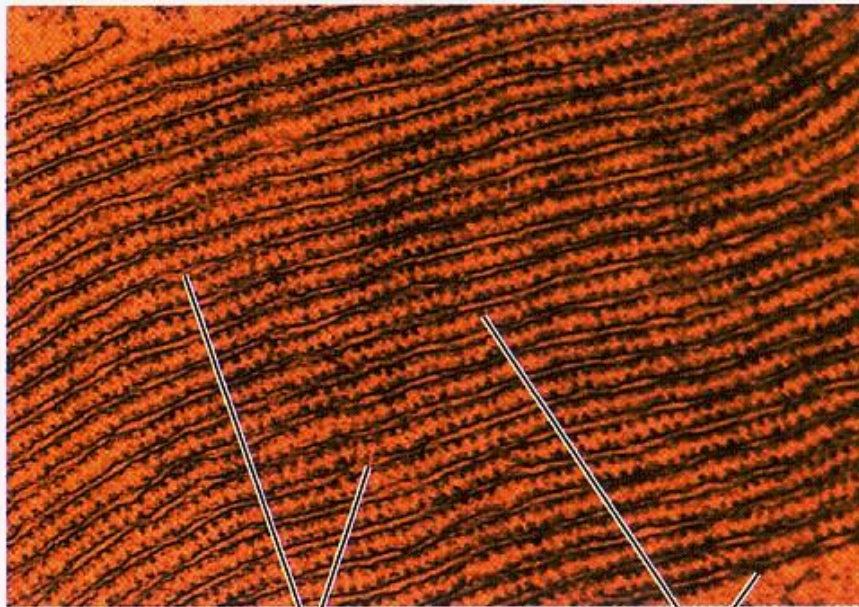

fig 2-2 LS 2012

# *Electron Micrographs of Rough vs. Smooth ER*



Rough ER lumen

Ribosomes

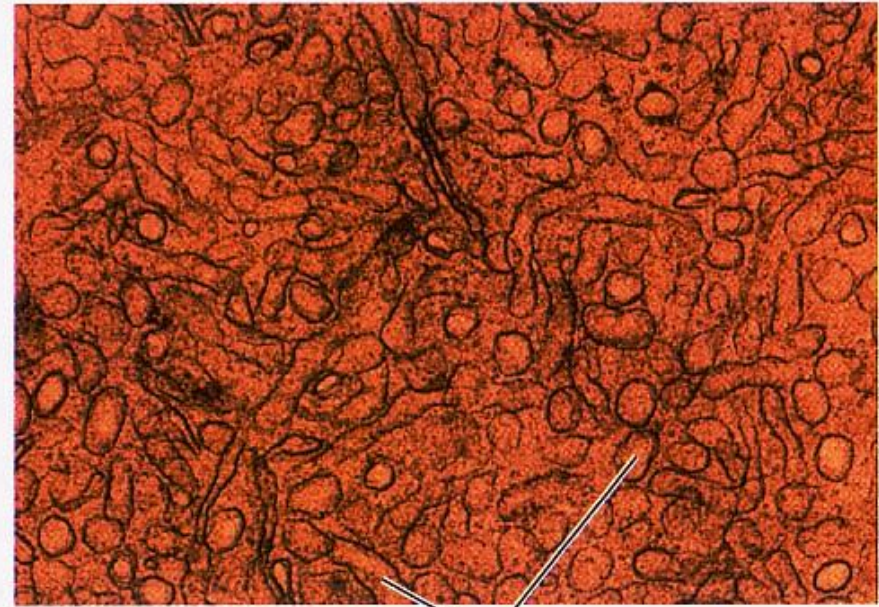

Smooth ER lumen

© Don W. Fawcett/Visuals Unlimited



# Secretion of Proteins Produced by ER

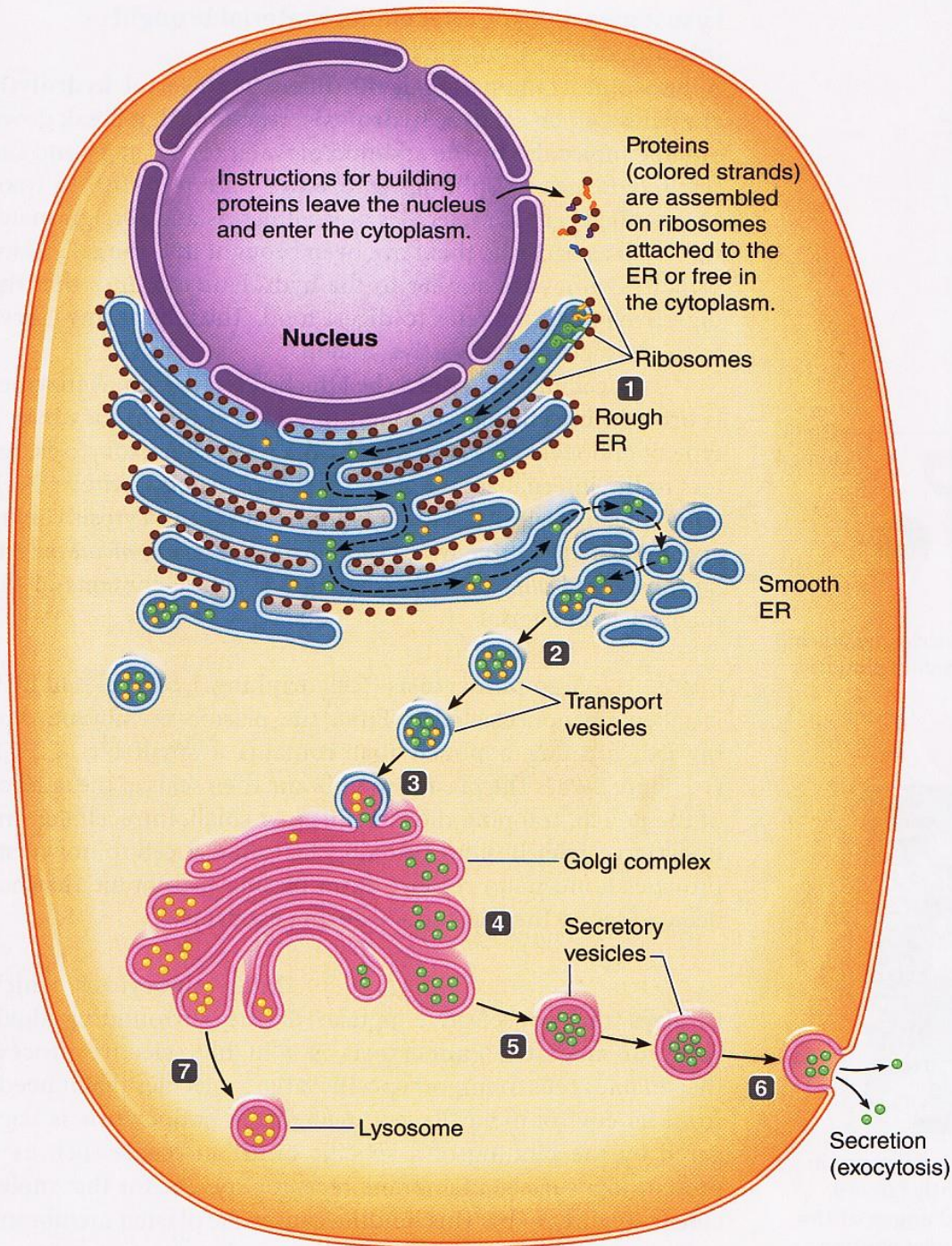
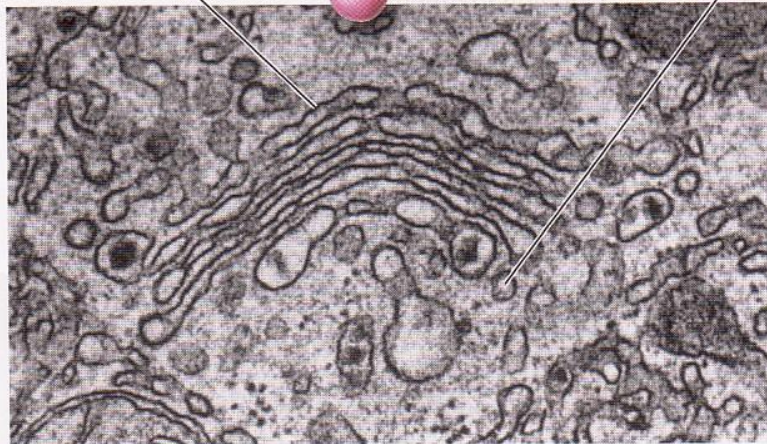
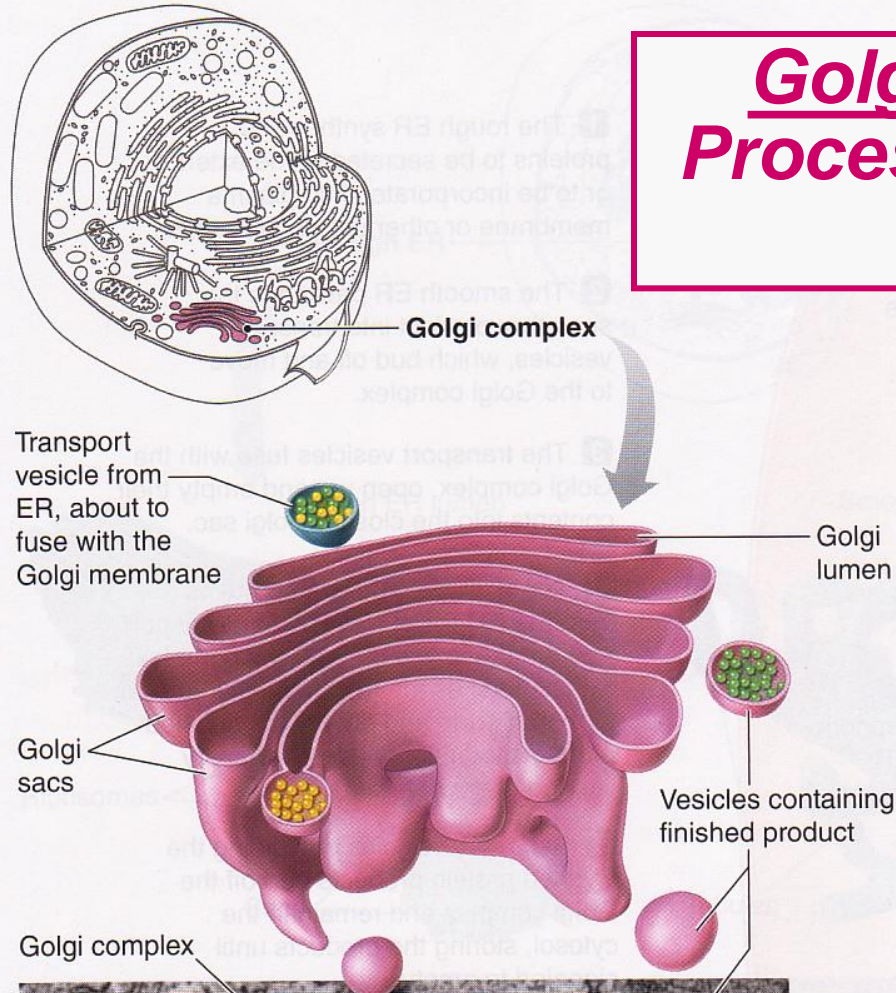

fig 2-3 LS 2012



# Golgi Complex: Final Processing, Packaging & Distribution



Dr. Don Fawcett & R. Bollender/Visuals Unlimited

fig 2-4 LS 2012



# Exocytosis: Primary Means of Secretion

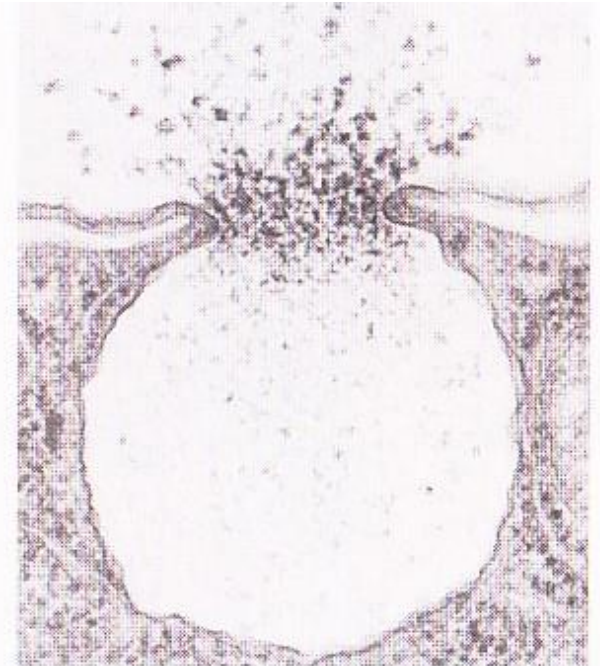
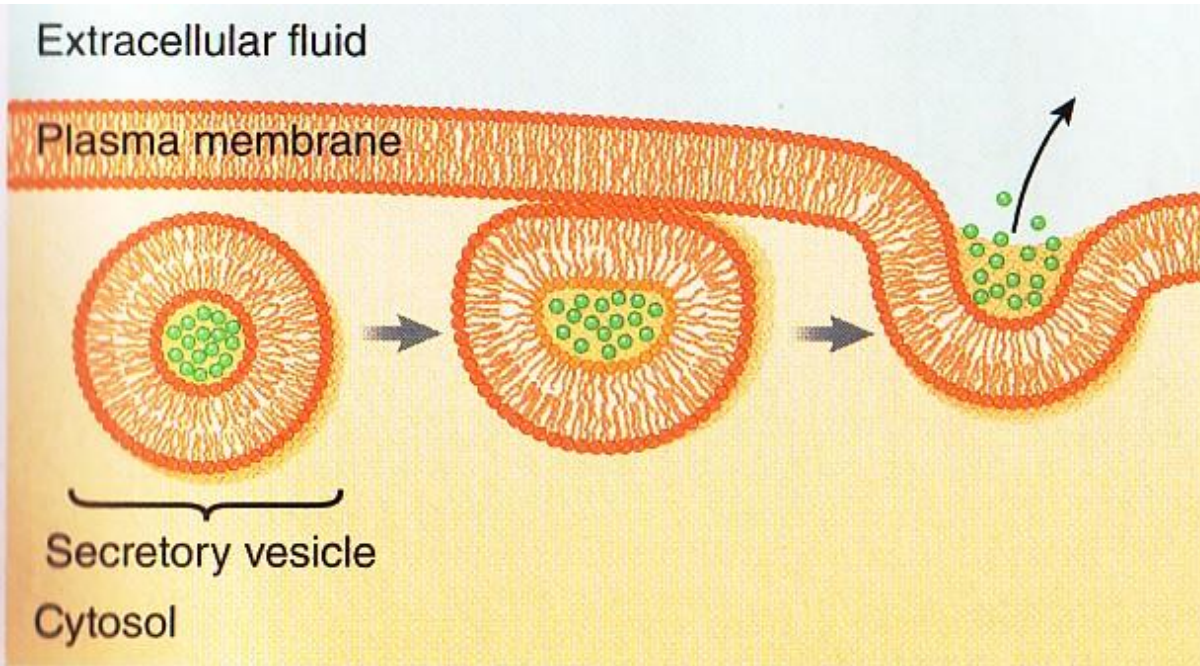

(a) Dr. Birgit Satir, Albert Einstein College of Medicine

# Endocytosis: Primary Means of Ingestion

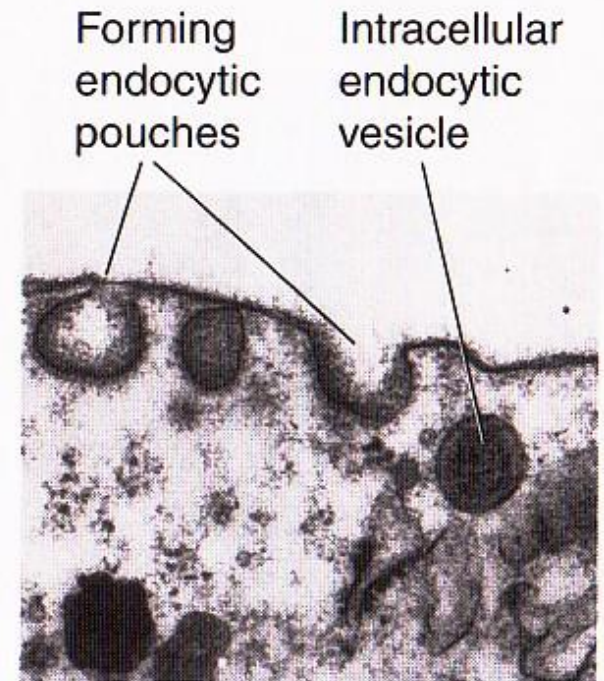
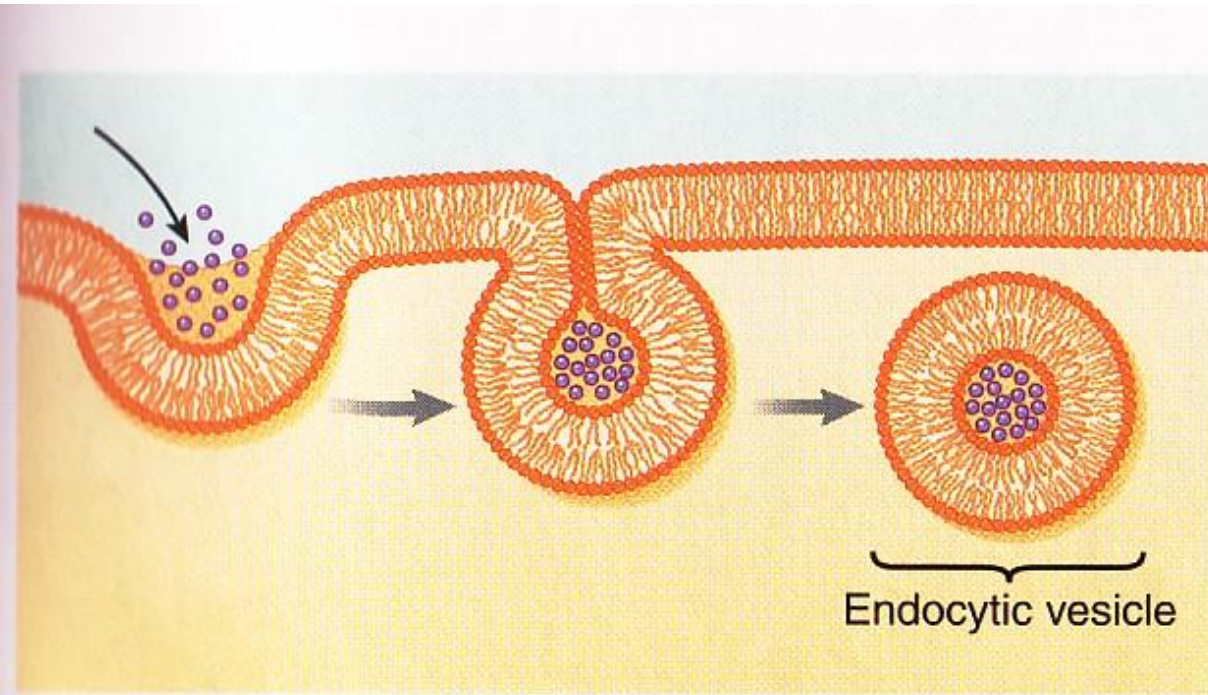

(b) © Don W. Fawcett/Photo Researchers, Inc.



# Lysosomes vs. Peroxisomes

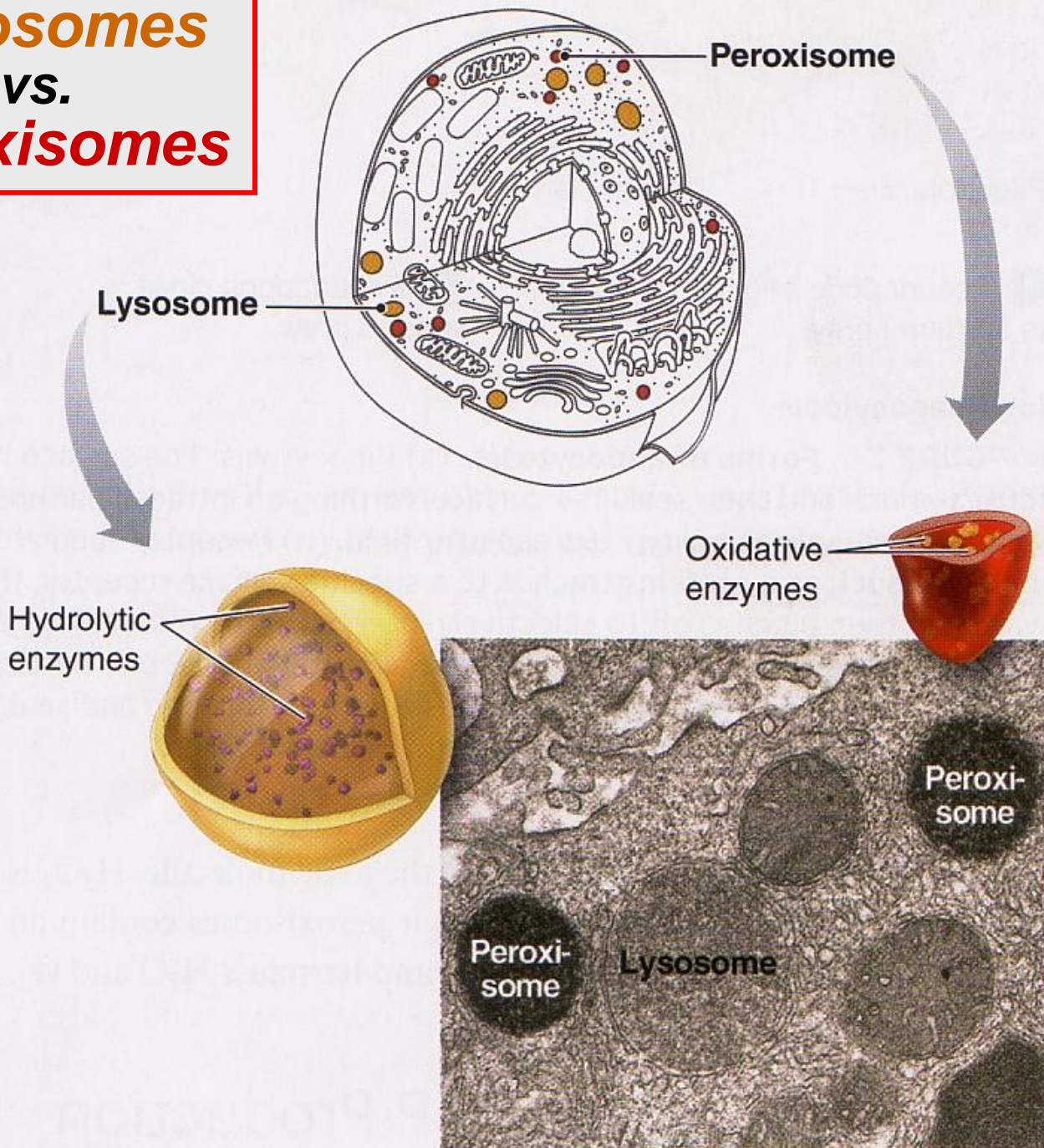

© Don W. Fawcett/Photo Researchers, Inc.

fig 2-6 LS 2012

# Phagocytosis: Cell Eating!

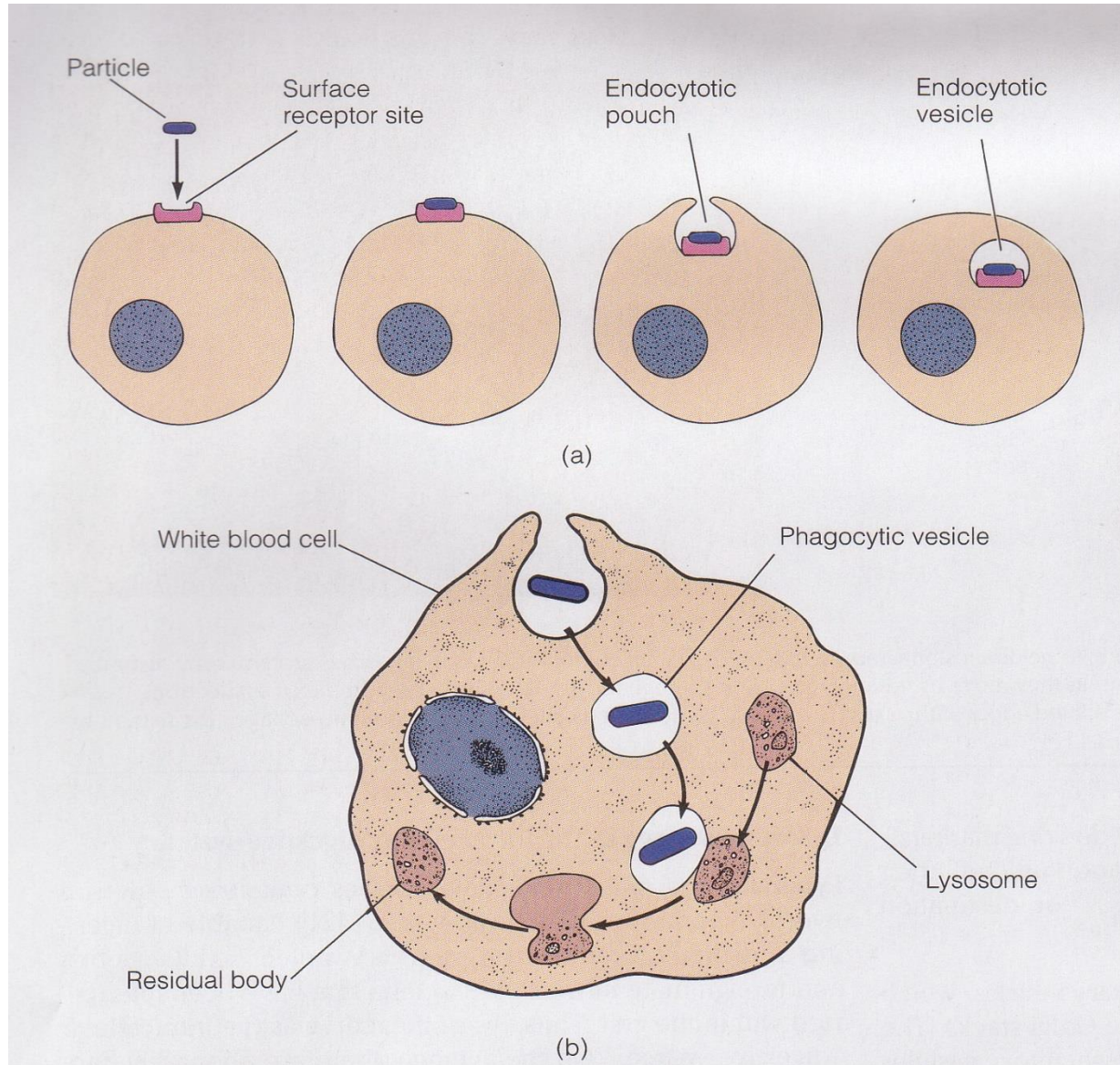





*Film: Neutrophil engulfing bacterium*

<http://devreotes.johnshopkins.edu/videos>



# *Catalase Enzyme Reaction in Peroxisomes Neutralize Toxin at Production Site!*

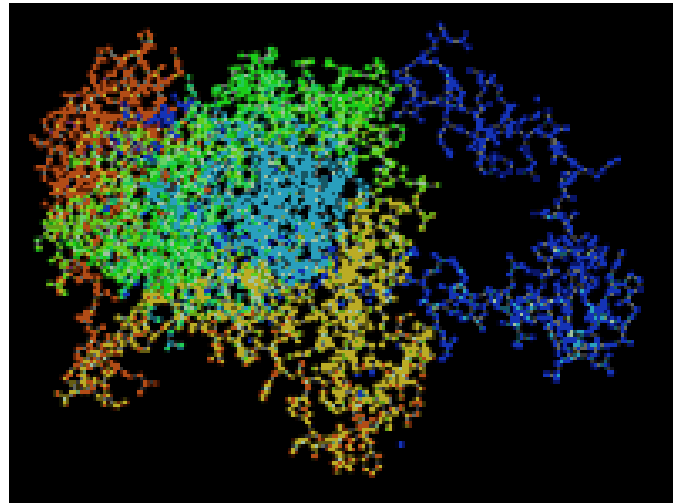

# Mitochondria: Energy Organelles

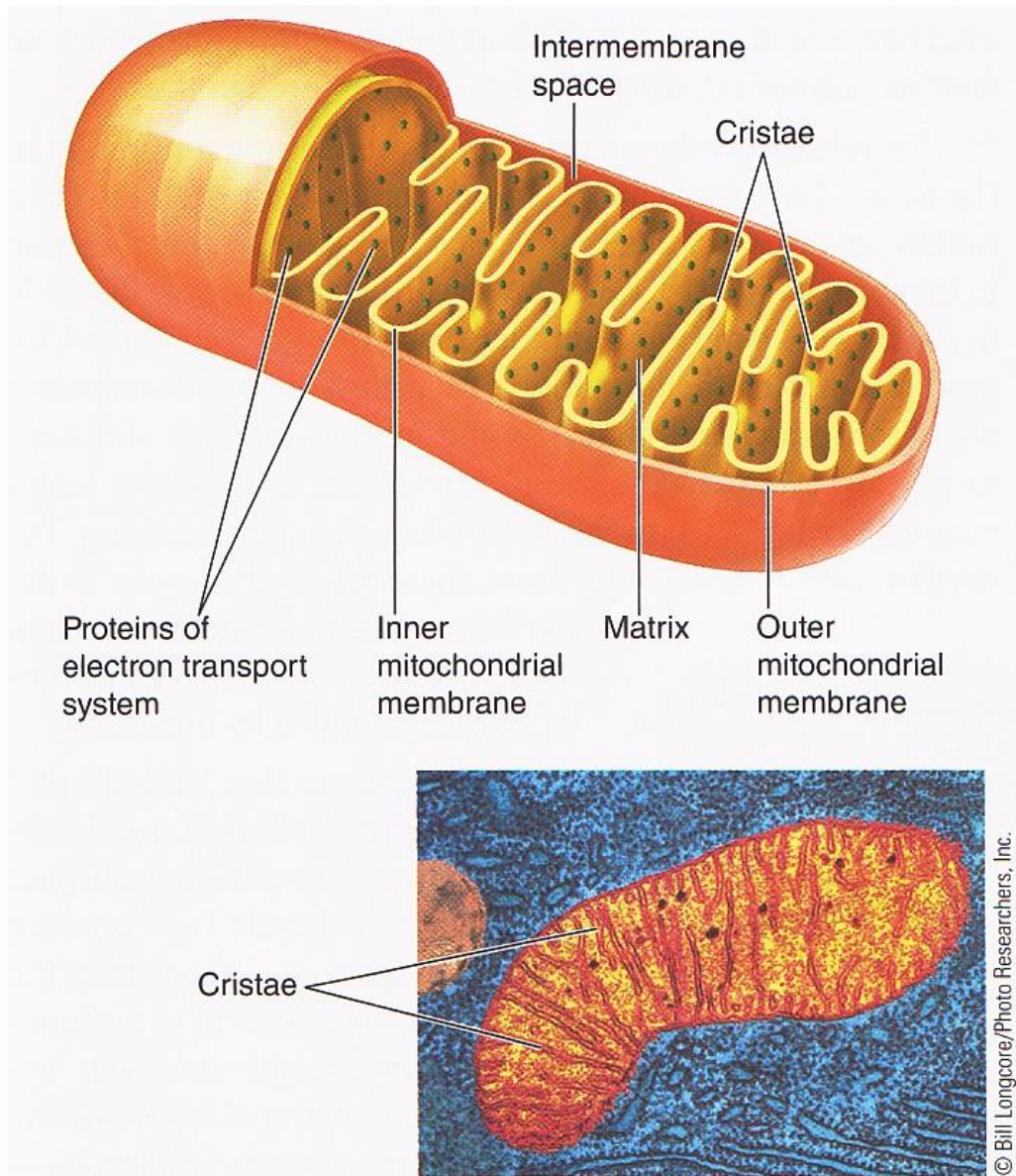

fig 2-8 LS 2012



