

Instruction Manual

For The Solar Pathfinder™

Solar Pathfinder™
3953 Marsh Creek Road
Linden, TN 37096

Order online:
www.solarpathfinder.com

FAX: 931-589-5400
Technical Support: 317-501-2529
E-mail: info@solarpathfinder.com

Copyright 2008 by Solar Pathfinder™
All Rights Reserved

Table of Contents

Parts Diagram (<i>Figure 1</i>)	3
Introduction	4
Diagram Selection	4
Sunpath Diagrams	4
By Application (Horizontal/Vertical)	4
By Latitude Bands	5
Sunpath Diagrams Available Chart (<i>Figure 2</i>)	5
Angle Estimator Grid Use and Interpretation	6
Instrument Set-Up	7
Magnetic Declination Picture (<i>Figure 3</i>)	8
Pathfinder Viewing	9
Site Tracing	9
Monthly Sunpath Diagram Interpretation	9
Site Tracing Example (<i>Figure 4</i>)	10
Converting Solar Time to Standard Time	11
Magnetic Declination	13
Magnetic Declination Explained	13
Magnetic Declination Web Sites	13
Magnetic Declination 2004 World Map	15
Magnetic Declination 2004 US Map	16
Considerations for System Placing & Sizing	17
Solar Radiation Data	18
Specific Aspects of PV System Siting & Sizing	20
Siting Solar Collectors	21
Siting Domestic Hot Water Collectors	21
Siting Active Space Heating Collectors	22
Estimating Rooftop Collector Shading on the Future Home	23
Seasonal Variations in Foliage & Ground Cover	24
Formulas	25
Instrument Care	26
Resources	26
Warranty	26
Statement of Liability	27

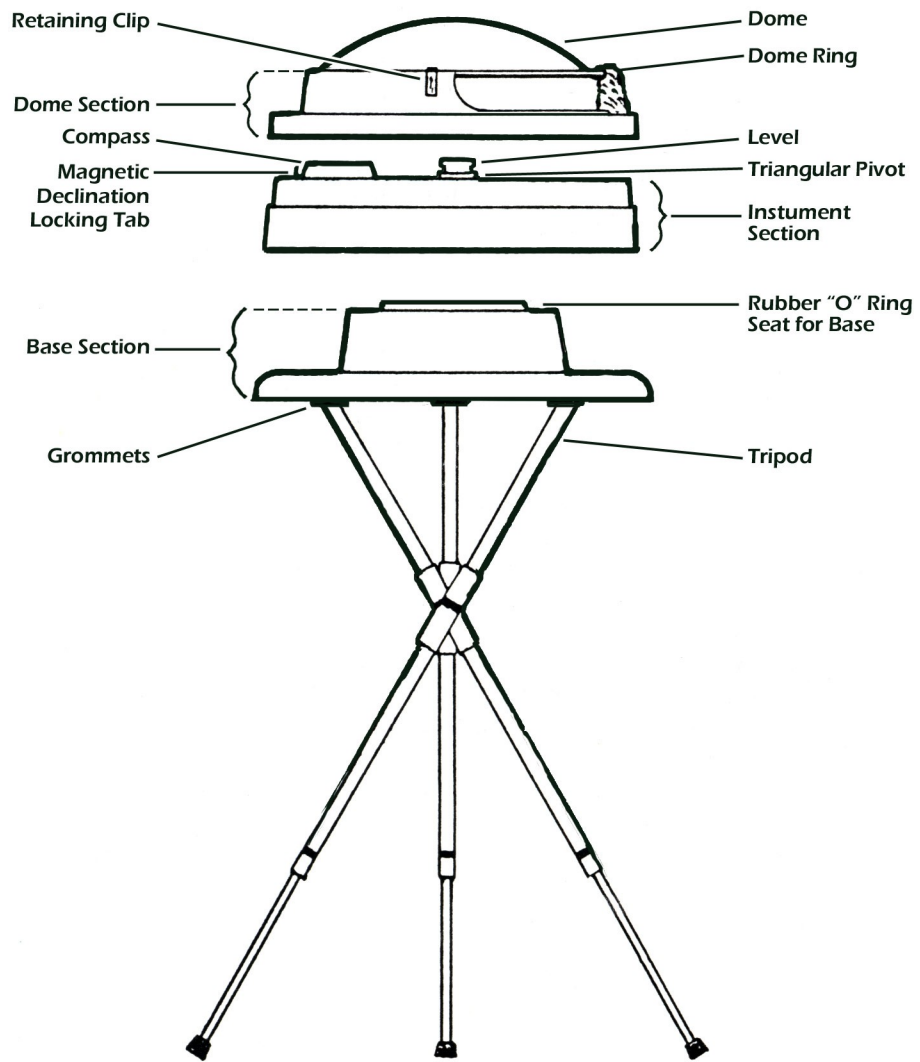

Figure 1

INTRODUCTION

The Solar Pathfinder™ is used for shade analysis (solar or canopy/habitat studies). Any trees, buildings, or other objects that could cast shadows are reflected in the plastic dome, clearly showing shading patterns at the site. The underlying diagrams are latitude specific and are engineered with data for the entire year. A wax pencil can be used to trace around the reflected shadows on the sunpath diagram, providing a permanent record of each reading. A compass and a bubble level are built into each Pathfinder™, making it easy to keep the instrument level and facing in the right direction. The rubber tipped legs on the tripod telescope out, allowing a person to use the Pathfinder™ on sloping roofs and other rough sites.

DIAGRAM SELECTION

There are two distinctly different diagrams used with the Solar Pathfinder™: the monthly sunpath diagrams and the two angle estimator GRIDS.

SUNPATH DIAGRAMS

By Application

The monthly sunpath diagram shows the percentage of solar energy that is potentially available at your site each month of the year. For the temperate latitudes there are two slightly different monthly sunpath diagrams:

- **Horizontal**
 - *for applications requiring 0-20 degrees tilt
 - *generally used in ecological studies or flat-roof PVs
- **Vertical**
 - *also called "South facing" ("North facing" in the southern hemisphere).
 - *for applications requiring 20-90 degrees tilt
 - *generally used in solar applications

The only difference between the Horizontal and Vertical diagrams is a slight change in the percentage of daily radiation shown in the half-hour periods along the sunpath arcs.

The radiation percentage figures on tropical diagrams (0-25 degrees latitude) assume a surface within 20 degrees of horizontal. High latitude diagrams (54-65 degrees latitude) assume a surface tilt of 20-90 degrees.

The Horizontal diagrams are used for nearly horizontal surfaces or collectors (those tilted at 20 degrees or less). Several entities use these for gauging shade and monitoring tree canopy. Most of these are fishery, riparian (along river), and ecological studies, but

range from bat roost to mushroom habitat studies. The vertical (South facing/North facing) diagrams are used for siting tilted collectors, and are usually used in solar applications.

By Latitude Bands

The latitude a location is located on the globe directly affects the sun's path. The closer a location is to the equator, the more overhead the sun is and the closer the sunpath arcs are to the center of the sunpath diagram.

Sunpath diagrams are available for the entire known populated world. The following chart indicates the diagrams available:

Sunpath Diagrams Available

Latitude Bands	Northern Hemisphere		Southern Hemisphere	
	Horizontal	South-Facing	Horizontal	North-Facing
0-4	✓		✓	
4-8	✓		✓	
8-12	✓		✓	
12-16	✓		✓	
16-20	✓		✓	
18-25	✓		✓	
25-31	✓	✓	✓	✓
31-37	✓	✓	✓	✓
37-43	✓	✓	✓	✓
43-49	✓	✓	✓	✓
49-51	✓	✓		
51-53	✓	✓		
54-46		✓		
57-59		✓		
60-62		✓		
63-65		✓		

Figure 2

ANGLE ESTIMATOR GRID USE & INTERPRETATION

The angle estimator is used to approximate the azimuth (degrees east or west of true south or north), and the elevation (degrees above the horizon) of any object reflected in the Pathfinder's dome. Some state and local governments are now using the angle estimator to determine the azimuth and altitude of shading and transferring that information to their own required sun chart or forms. The clear angle grid is also used as an aid in siting collectors (See the Section on **Siting Collectors.**), in estimating shading for future pole mounts or rooftop PVs (See the Section on **Estimating Shading for the future Rooftop/Pole Mount Collector**), and with other formulas (See **Formula Section**).

To measure the azimuth, use the radial lines, which are spaced 10 degrees apart. To measure the elevation, use the concentric circles, which are also spaced 10 degrees apart.

Note: On this angle measurement grid, lower elevation angles are not measured as accurately as higher elevation angles. Finding the **difference** of elevation or azimuth between two objects is usually more accurate than measuring the elevation or azimuth of each object by itself.

INSTRUMENT SET-UP

The Solar Pathfinder™ is made up of three sections:

Dome section; the part with the translucent lens/dome;

Instrument section; the part with the compass and level;

Base section; the part with the rubber grommets.

To avoid accidentally dropping the dome section, it should be set aside until the tripod, base, and instrument section are securely assembled. Save the plastic bag for storing the Pathfinder™ dome section when it's not in use. The transparent, reflective lens is easily scratched.

Step 1: Insert the rounded ends of the tripod legs sequentially into the rubber grommets on the base. Pull on the bottom end to slide out the inside tripod leg sections. You will want to lean over the dome and have your eye about 15 inches above the dome. Adjust the legs to get the base approximately level. The base doesn't need to be precisely level, as the instrument section will rock in the dish shaped base to finish adjusting the leveling and the directional orientation of the Pathfinder™.

Step 2: Put a paper sunpath diagram over the center pivot of the diagram platform of the instrument section.

Step 3: Adjust the Pathfinder for the proper magnetic declination; gently pull out the brass Magnetic Declination Tab located by the compass 1/4". This will allow the center triangle and black disk to easily pivot. The "number line" on the perimeter of the diagram is for magnetic declination adjustment. The numbers to the left of "0" are "west of north" are negative numbers (just like your "number line" in school); the numbers to the right side of "0" are "east of north" or positive numbers.

Rotate the sunpath diagram on the central pivot to adjust for the magnetic declination:

- counterclockwise for declinations to the east of north (positive numbers) {the western continental US}, or
- clockwise for declinations to the west of north (negative numbers) {the eastern continental US}.

See the pages 16 & 17 of this manual for magnetic maps of the U.S. and for the world. For a better understanding of what magnetic declination is and how to find your exact declination see the *magnetic declination* section of this manual.

Line up the declination number with the small white dot on the rim of the base. *Figure 3 shows the magnetic declination for 11 degrees East of North.* The Solar Pathfinder™ will now

point "true" south. Relock (push in) the brass Magnetic Declination Tab (located by the compass).

↓ White Dot



↑ Magnetic Declination Tab

Figure 3 Magnetic Declination for 11 degrees east of north (+11 degrees)

Step 4: With the Sun path diagram locked to its proper declination set the instrument section onto the base. Slide it around on the cupped base making adjustments until the bubble is in the middle of the level. If you can't get the instrument level this way, readjust the tripod legs and try again. At the same time you will be rotating the instrument section until the red pointer of the compass is pointing directly above the "N". This is **magnetic** south. *[The Southern Hemisphere will have the compass mounted opposite on the instrument section].* A word of caution -- any ferrous material can seriously affect the direction of the compass. Example: when working near buildings with large metal beams, move the compass away from beams until compass needle direction stabilizes. Find a distant true south reference point, and then set the Pathfinder™ up at the original site using that reference point.

Step 5: Place the dome section on top of the instrument section. The opening on the side of the dome section should be opposite the compass to allow the wax pen to be inserted for marking on the diagram. You are now ready to do your site tracing.

PATHFINDER™ VIEWING

The Solar Pathfinder™ is designed to be viewed from between 12-18 inches above the dome and within 10-15 degrees of the vertical centerline on the sunpath diagram. Site readings are best taken on cloudy or overcast days to avoid glare from the sun. On a sunny day, block the sun's image with your free hand. **CAUTION: DO NOT STARE AT THE REFLECTED IMAGE OF THE SUN ON THE PATHFINDER™ DOME.**

When viewing the Pathfinder, you are looking for two things at the same time. First a reflective, panoramic view of the site will be seen **on** the dome. Simultaneously, the sunpath diagram will be seen **through** the dome. The view of the site reflected onto the sunpath diagram is what gives the viewer the site specific solar information.

SITE TRACING

The Solar Pathfinder™ is supplied with white pencils to make it easy to write directly on the sunpath diagrams. To record a site reading, trace around the objects reflected on the dome directly onto the sunpath diagram while viewing from about 15 inches above the dome.

To avoid breaking the pencil lead, make a light tracing working under the dome, and then remove the dome to darken it. If the tracing is to be analyzed later, make note of any deciduous trees so that adjustments can be made as suggested in the section on **Seasonal Variations in Foliage and Ground Cover**.

Note: Clouds should not be counted as shade. See the section on **Considerations for System Sizing** for a discussion of climactic factors.

MONTHLY SUNPATH DIAGRAM INTERPRETATION

The monthly sunpath diagram contains 12 horizontal arcs, one for each month, as well as vertical lines or rays for solar time. Each arc shows the mean sun's path across the sky for that month. The sunpath arc for December is farthest from the center of the Pathfinder™,

showing the lowest winter sunpath through the sky. The sunpath arc for June is closest to the center, showing the highest summer sunpath (opposite in the southern hemisphere).

A solid white radial line shows each half-hour division. Solar time is approximately standard time at the center of each time zone. Generally, the farther you are from the center of your time zone, the greater the difference will be between solar time as shown on the Pathfinder™ and the time shown on your wristwatch. (See **Converting Solar Time to Standard Time** for more information.)

The small white numbers inside the half-hour divisions are values that have been calculated to account for the **relative** energy in each half-hour. This is necessary because a half hour near noon can provide a lot more energy than a half hour early or late in the day. The numbers along each sunpath arc add up to one hundred percent.

To find the site percent, add the numbers in the unshaded part of the sunpath arc. The site tracing shown in *figure 4* has 64% solar available for January, found by adding 2 + 3 + 4 + 5 + 6 + 7 + 7 + 8 + 8 + 8 + 6 = 64%. This shows that only 64% of the potential available radiation is reaching this particular location during January. 36% of the potential available radiation is blocked out in the middle of the winter.

Monthly Sunpath Example

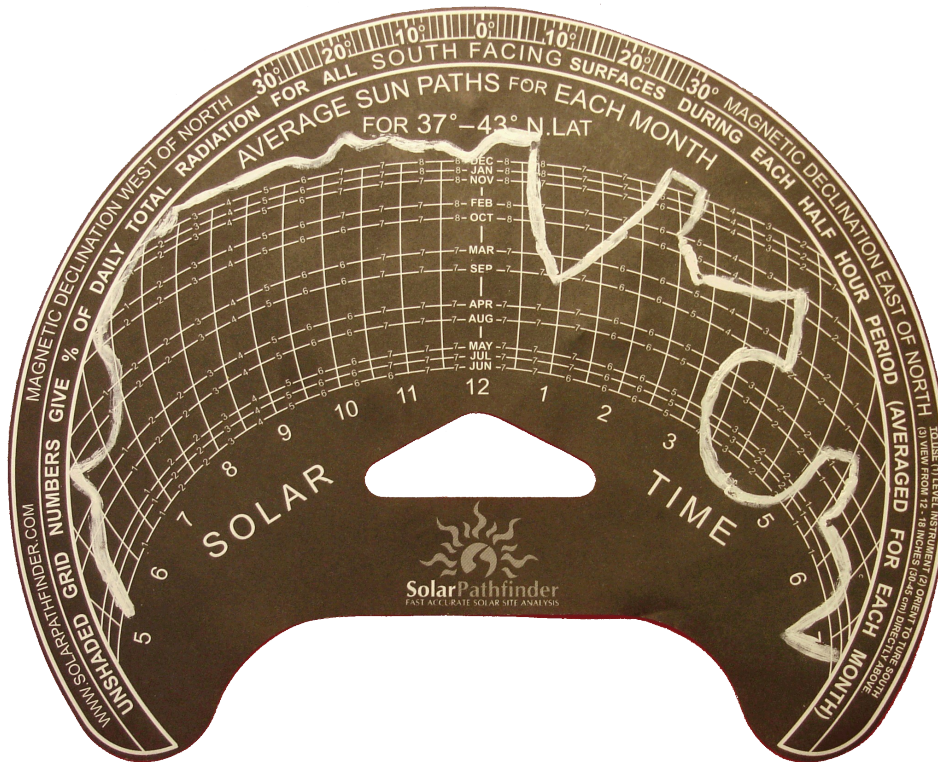

Site Tracing on a Monthly Sunpath Diagram

Figure 4

CONVERTING SOLAR TIME TO STANDARD TIME

The sunpath diagrams show solar time. If it is important to you to convert the solar time on the diagram to the time shown on your wristwatch, you need to convert solar time to standard time. You will need to make two corrections:

1. For the time of year, because the earth is both tilted on its axis and accelerates and slows down in its elliptical orbit around the sun. The combined effect can account for around plus or minus 15 minutes. The following is a chart that shows average monthly corrections in minutes (These are independent of the hemisphere.).

Monthly Corrections in Minutes

January	+ 8	July	+ 5
February	+13	August	+ 4
March	+ 8	September	- 6
April	+ 1	October	-14
May	- 4	November	-14
June	- 1	December	- 7

2. Longitudinal, for the distance you are located from the center of your time zone. This usually is limited to plus or minus 30 minutes, but due to politically altered time zone boundaries, can be more.

There are 24 time zone ribbons circling the globe, extending from north to south through the poles. Each time zone is 60 minutes wide. Right down the middle of each of these zones, solar time essentially equals conventional time. If you are not on the mid-line, add or subtract minutes to or from the Solar Time shown on the Pathfinder™ diagram to get closer to conventional time. **Add** minutes for locations **west** of the middle, and **subtract** minutes for locations **east** of the middle.

For example, if we are halfway between the center of the time zone, and its **western** edge, we would **add** 15 minutes to the solar time (one-half of the 30 minutes from the center to the western edge). If we are two-thirds of the way from the middle of the time zone to its **eastern** edge, we would **subtract** 20 minutes from the solar time (two-thirds of 30 equals 20).

You will likely need to straighten out the time zone lines in your mind or on paper, as most maps show the zigs along politically induced time zone boundaries.

Example: For Sioux Falls, SD, in June:

Solar Time from Pathfinder™:	3:20 PM
Monthly Correction (See Monthly Correction Chart above):	-1 min.
	3:19 PM
Time Zone Correction -- 1/2 times 30 mins)	+15 min.
Central Standard Time	3:34 PM
Daylight Savings Time	+ 1 hour
Conventional Time	4:34 PM

Sustainable by Design has a really neat web page that has a program that converts solar time to conventional time (among other things). You can reach them on the Web at <http://www.susdesign.com/sunangle/index.html>.

MAGNETIC DECLINATION

Many people are surprised to learn that a magnetic compass does not normally point to **true north**. In fact, over most of the earth it points at some angle east or west of true (geographic) north. The direction in which the compass needle points is referred to as **magnetic north**, and the angle between magnetic north and the true north direction is called **magnetic declination**. Other terms used are: "variation", "magnetic variation", or "compass variation".

Magnetic Declination Explained

The magnetic declination does not remain constant in time. Complex fluid currents of the elements iron, nickel, and cobalt flow in the outer core of the earth (the molten metallic region lies from 2800 to 5000 km below the earth's surface) generating a magnetic field. The poles of this field do not coincide with the unchanging true north and south - the axis of rotation of the earth. The change in the magnetic fields is known as **secular variation**.

Local anomalies originating in the upper mantle, crust, or surface, cause further distortions. Ferromagnetic ore deposits; geological features, particularly of volcanic origin, such as faults and lava beds; topographical features such as ridges, trenches, seamounts, and mountains; ground that has been hit by lightning; cultural features such as power lines, pipes, rails and building; personal (ferrous) man-made items such as a stove, steel watch, or even your belt buckle, frequently induce an error of three to four degrees. If you think there are iron deposits in your area, you will want to check with a local surveyor to make sure you are pretty close on the magnetic declination.

Magnetic Declination Web Sites

Secular variation causes declination values to constantly change. When printed maps were the only way of getting this information, the declination values were somewhat out of date by the time the maps got to the general public. In this computer information age that we live in, you can get current information for your exact location. Some web sites for magnetic declination are listed below. With some of them you can even get "historic" information and future predictions concerning any latitude/longitude by inserting different dates. The most recent declination maps are included in this manual. The declination maps for the world and the US are included in the manual.

Australia

<http://www.ga.gov.au/oracle/geomag/agrfform.jsp>

You need to know your latitude and longitude for this site. Scroll down the page and enter your latitude, longitude, altitude, etc. Put a check next to "D" (declination) for the Main Field;

Submit Request. Example: for -30° latitude, 138° longitude (date: May 1, 2003), the declination is 7.157° (7.157 degrees). For your purposes, round the number of minutes up or down to a whole number and use that number for the magnetic declination.

Canada

http://www.gsc.nrcan.gc.ca/geomag/field/mdcalc_e.php

You can either choose a city or type in your latitude and longitude; and then click "Calculate Magnetic Declination". Example: for Vancouver, British Columbia (123° longitude; 49° latitude, year 2005) the declination is $18^\circ 50'E$ (18 degrees, 50 minutes East). For your purposes, round the number of minutes up or down (60 minutes = 1 degree) and use that number for the magnetic declination.

United States

<http://www.ngdc.noaa.gov/seg/geomag/jsp/Declination.jsp>

Put your zip code in the appropriate box and click on the "Get Location" button. The site will automatically write in your exact latitude and longitude. Type in the date etc (current date is the default); click on "Compute Declination" to calculate the magnetic declination.

Example: for Linden, TN 37096, the latitude is 35.599784 and the longitude is 87.865582; on May 1, 2003 the magnetic declination is $1^\circ 30'W$ changing by $0^\circ 6' W/year$ (i.e. "one degree, 30 minutes West"). For your purposes, round the number of minutes up or down (60 minutes = 1 degree) and use that number for the magnetic declination (in the example, you could round the degrees off to 2° West of North (negative side of the number line) and rotate the magnetic declination dial clockwise to -2 degrees).

2004 World Map Magnetic Declination

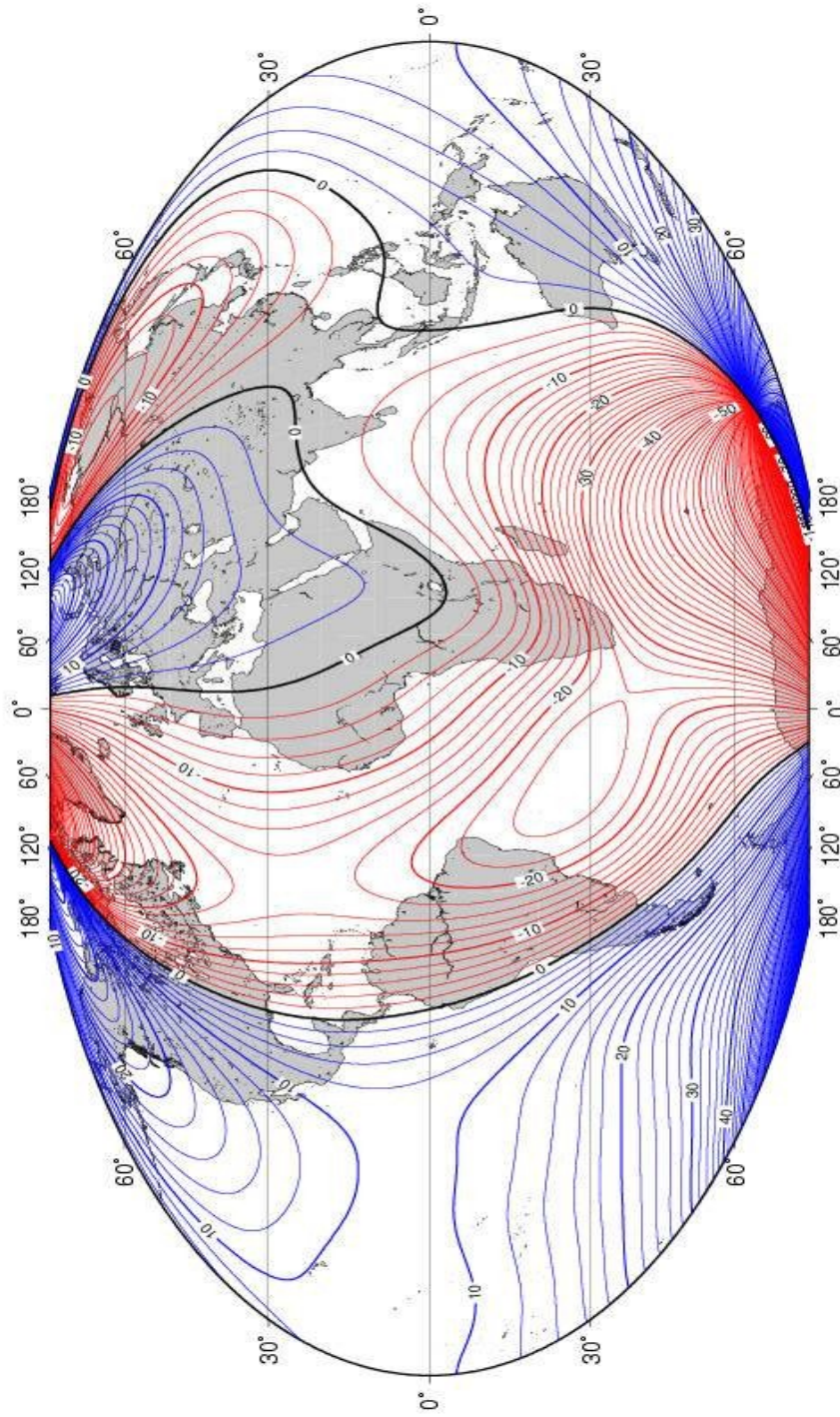

2004 United States Map Magnetic Declination

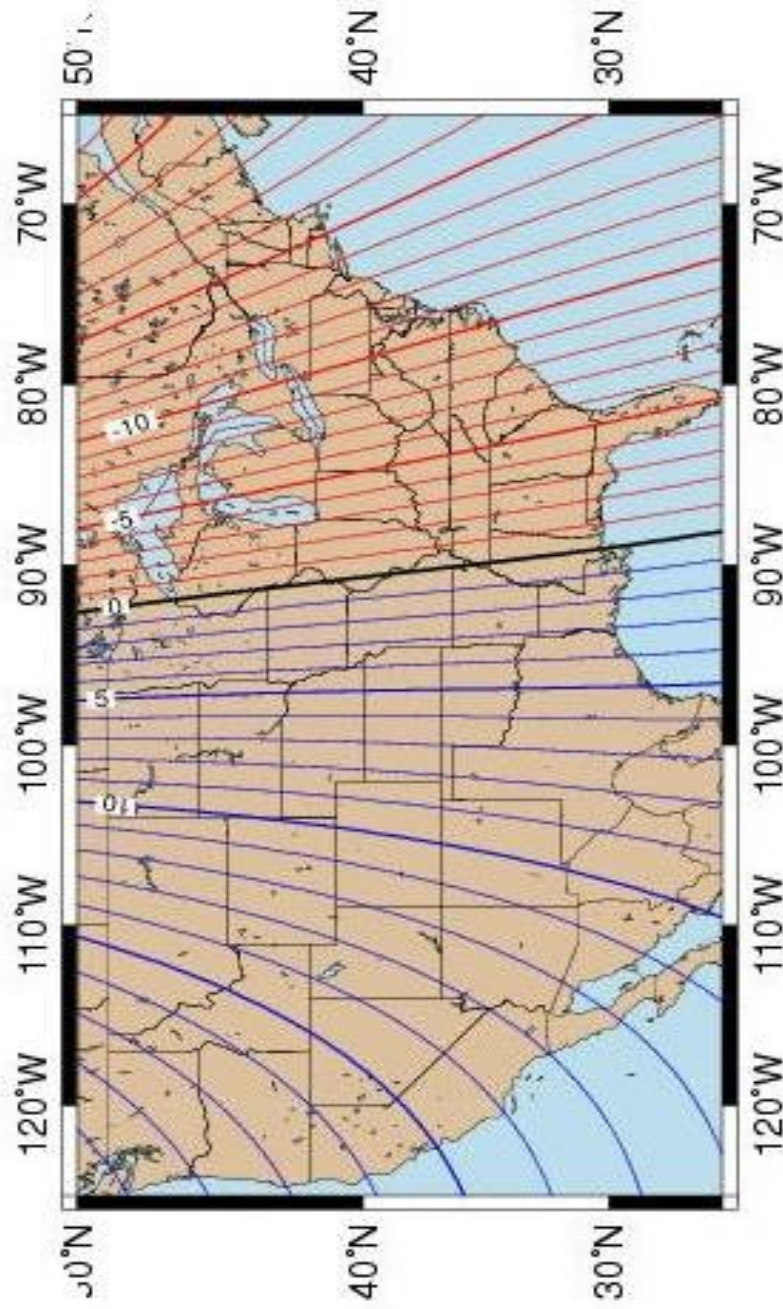

CONSIDERATIONS FOR SYSTEM PLACING & SIZING

SYSTEM PLACING

The Pathfinder™ is easily moved, so tracings can be taken at other locations at your site, allowing you to evaluate different places.

This information, along with considerations of cost and feasibility, will allow you to pick the best location for your collector. For example, a solar collector location farther from the batteries could have less shading, but would cost more for the longer, larger wires needed. Once you have weighed the tradeoffs and settled on your site, you can use the Pathfinder's information in system sizing.

SYSTEM SIZING

The basic questions that need to be answered to determine the size of a solar collection system are:

1. How much heat or electric energy is needed?
2. What type of collector will be used?
3. How much energy will be lost between the collector and the point of use?
4. How does the slope and orientation of the collector affect the amount of solar energy received?
5. How much of the sun's energy that could potentially reach your collector surface actually will? A percentage of the sun's radiation can be blocked by trees, buildings, hills, clouds, dust, water vapor in the air, and other things.

The Solar Pathfinder™ instrument will help you answer the fifth question. The Pathfinder™ is primarily designed to determine the percentage of solar radiation blocked by **permanent** local features in the landscape like trees, hills, and buildings. **Climatic factors**, such as the amount of clouds, dust, and water vapor in the atmosphere are constantly changing. We need to account for these climatic factors to determine the average amount of solar radiation actually received at a certain location at a certain time.

The best way to account for climatic effects is to take actual solar radiation measurements with special radiation measurement instruments. Clouds, dust, and water vapor scatter and absorb a part of the incoming solar radiation. The amount of solar radiation that actually reaches the earth's surface is measured with these instruments. The best solar radiation data comes from locations that have been collecting this data over a long time period. This data contains average, maximum, and minimum values for the amount of solar radiation that strikes the collectors at these locations. The problem is that there are only a very small number of these locations around the world.

SOLAR RADIATION DATA

In the United States, a major program was undertaken by NREL (National Renewable Energy Lab) to correlate sparse solar radiation data with available weather data at nearby sites. These correlations were used to estimate solar radiation for 239 sites in the US with extensive weather records. The data for the 239 sites is available in an excellent 250-page publication called **Solar Radiation Data Manual for Flat-Plate and Concentrating Collectors**. The data is available in HTML and PDF format from the website

<http://rredc.nrel.gov/solar/pubs/redbook/>. Individual PDF files are available for the main body of the manual and for each of the 50 states, the Pacific Islands (Guam) and Puerto Rico. Compressed files containing the individual PDFs for the manual and the site data tables can be downloaded in three compression formats: PC, Macintosh and Unix. Maps derived of the data represented in the tables are also available for viewing.

NREL is an excellent resource, and though it tends toward the large utility scale projects, it is funded by your tax dollars. If you have additional technical questions, try 303-275-4626 or 4648. Like most NREL numbers, you will likely get a machine.

The manual mentioned above has a page of tables for each location. The data tables have columns for each month of the year and an annual total. There are five tables: south facing fixed-tilt collectors, 1-axis trackers, 2-axis trackers, direct-beam concentrating collectors, and average climatic conditions. Units are metric (kilowatt-hour per square meter per day). Most tables give average, maximum, and minimum values for each month. The fixed and 1-axis tracker tables are broken down into tilts of: horizontal, latitude minus 15 degrees, latitude, and latitude plus 15 degrees.

Sandia Laboratories publishes a useful manual: **"Stand-Alone Photovoltaic Systems, A Handbook of Recommended Design Practices"** (SAND87-7023) and **Photovoltaic Power Systems and the National Electric Code Suggested Practices** (SAND96-2797). **"Stand-Alone PV"** is a 400+ page reference that has 70 pages of radiation data, much of it for locations outside the U.S. Data is monthly for fixed array, 1-axis trackers, and 2-axis trackers. Tilts include latitude minus 15 degrees, latitude, and latitude plus 15 degrees. Contoured world maps are included for each season of the year and each of the three tilts above. This can be ordered from Sandia Laboratories at 505-844-4383; their website is <http://www.sandia.gov/pv/>

International solar irradiation database:
<http://energy.caeds.eng.uml.edu/fpdb/irrddata.asp>

Select country ("Use Location" box); select "full detail" ("Set Detail" box); click "Search".

There are a number of people and organizations working at different computer based systems for middle and large scale projects that manipulate radiation and Solar Pathfinder™ data. This field is changing so fast that individuals are encouraged to do their own research.

A simple installation of a few PV panels on a cabin project could use the equivalent sun-hours per day chart that came with the PV panel literature. This literature from some PV panel manufacturers will give rough numbers, but will be very simple to use. PV panels are usually rated as producing so many amps at near ideal or peak sun conditions. Then the amp rating for the panel can be multiplied by the number of peak sun-hours, to get the number of amp-hours per day that can be produced by the panel.

One peak sun-hour is equivalent to one kilowatt-hour per square meter per day when the PV panels' tilt has been optimized for the entire year. The kilowatt-hour per square meter per day is the unit for radiation data that is provided in the **Solar Radiation Data Manual** available from NREL. The suggested tilt angle that is optimum for the entire year is the one tilt angle where a PV panel will produce the most electricity in a year's time.

The optimum tilt angle could be roughly estimated as being the latitude of the location. Actually, the optimum tilt may be as much as 10 degrees or more off a tilt equal to latitude. For instance, if the summers are much sunnier than the winters, then you will want to tilt the collector more toward the summer sun for maximum gain, which means your tilt will be more horizontal (less than your latitude). Of course, most of your energy use may be in the winter, so instead of maximizing total energy for the year, you might want to maximize your winter collection by increasing the angle of tilt.

There are many tradeoffs and considerations that will play into sizing and orienting solar collectors, and it will be wise to use an installer-dealer with extensive background. (Many advertise in Home Power Magazine referenced in **Resources** at the back of this manual.)

SPECIFIC ASPECTS OF PV SYSTEM SITING AND SIZING

Photovoltaic panels are affected by partial shade more than other types of collectors. Shade over a portion of the panel can greatly limit power output. **Partial shade from towers, poles, deciduous trees and other objects would be considered nearly the same as total shade for older panels.** PV manufacturers are gradually reducing this problem. **Several locations should be evaluated to find the one with the greatest collection potential.**

Output will also be affected by the use of trackers, or the number of fixed panel adjustments made during the year. Much additional layman information can be gathered from the **Stand-Alone Photovoltaic Systems Manual** from Sandia Labs, referenced under **How To Get Solar Radiation Data** above.

To find the expected power output from fixed solar panels:

Step 1: Use a South-facing monthly sunpath diagram (for the northern hemisphere) for your site tracing. Add the numbers in each half-hour period for which there is **no shading on the planned panel array**. For large arrays, **two readings** should be taken, at the east and west bottom edges of the planned array. Both can be recorded on the same sunpath diagram. Then add the numbers in the half-hour periods when there was no shading on either tracing to find the percent of solar radiation available for each month.

Step 2: Multiply this percentage by the radiation amount you obtained from one of the data sources listed above (NREL, etc.). The radiation data gives you the number of kilowatt-hours per day, or the number of peak-sun hours which, number wise, is essentially equivalent. (Peak sun-hours are also referred to as "sun-hours" or "equivalent hours of peak output" or "optimum sun-hours" by different sources. See an explanation of sun-hours in **How to Get Solar Radiation Data** above.)

Step 3: Using the resultant number of **sun hours** from Step 2 above, multiply by the **optimum amps or ampere output under full sun** (available from the panel manufacturer) to find the expected average **ampere-hours per day** for each month. Multiply by the panel voltage to get watts per day.

Example: Using the site tracing on *figure 4*, add the numbers for the half-hour segments in December when **no shading** will occur: $2 + 3 + 4 + 5 + 6 + 7 + 7 + 8 + 8 + 8 = 58\%$. In the NREL

publication under Grand Junction, CO, in December, a south facing fixed collector tilted at latitude (which is 39 degrees) receives on average 4.1 kWh/m²/day (4.1 X .58 = 2.4 kWh/m² day). This would be about 2.4 peak sun-hours per day for December at this site. Multiplying 2.4 by the panel manufacturer's value for optimum amps (let's use 3.02 amps) gives us 7.2 amp-hours per day. Multiply by voltage (let's use 12v) gives us 86 watts per day.

SITING SOLAR COLLECTORS

SITING DOMESTIC HOT WATER COLLECTORS

The most ideal water heat collector orientation will typically favor the winter months slightly, to make up for shorter days and the cooling effect of colder temperatures. The panel tilt might equal the latitude plus five to ten degrees. Although partial shading isn't as critical with thermal collectors as with PV panels, we still need to compensate for a high percentage of morning or afternoon shade. To do this, we need to aim the panels more to the west or east, and possibly increase the tilt.

Step 1: Using the diagram shown on *figure 4*, add the numbers in the **unshaded** part of the October sunpath to find the site percent for October. For example, the monthly sunpath diagram on *figure 4* has an October reading of 71%.

Step 2: Divide this number by two to find the half-day percentage. $71/2 = 35.5\%$; round up to 36.

Step 3: Start from the east edge of the October sunpath, add the **unshaded** numbers until the total is nearly the same as the half-day percentage. $2 + 3 + 4 + 5 + 6 + 6 + 7 = 33$.

Step 4: Notice the place along the October sunpath where the half-day percentage is found, in relation to 12 noon (true south). In our example, the half-day percentage is found between 11:00 and 11:30 AM.

Step 5: Overlay the clear angle measurement grid on top of the sunpath diagram. Using the angle numbers on the outside edge of the grid (the azimuth angle), find the angle where the half-day point is located.

Using our example, for between 11 and 11:30 AM, the angle is 15 degrees. Therefore, we would orient our collector 15 degrees east of south.

Step 6: To determine the collector's tilt, use the azimuth angle found above (15 degrees in our example). Divide the azimuth angle by 5 and add this figure to your latitude to find the collector's tilt. As an example, use our 15 degrees azimuth angle and our latitude of 39 degrees north. We would first divide 15 by 5 to get 3, and then add this to the 39 degrees of latitude to get a collector tilt of 42 degrees. This is due to the greater percentage of energy coming in while the sun is lower in the sky (i.e., morning or afternoon).

SITING ACTIVE SPACE HEATING COLLECTORS

Since space heating is a concern primarily during the winter months, we will use the information from the January sunpath to orient the collector. (A good rule of thumb for panel tilt is latitude plus 15 degrees.)

Step 1: Again using the diagram shown on *figure 4*, add the numbers in the **unshaded** part of the January sunpath to find the site percent for January, and divide by two to find the half-day percentage. Our example shows that the site percentage is 64%. $64/2 = 32$.

Step 2: Starting from the east edge of the January sunpath, add the **unshaded** numbers to find the half-day point. $2 + 3 + 4 + 5 + 6 + 7 = 27$.

Step 3: Notice where this half-day point is in relation to 12 noon (true south). In our example, the half-day point is between 10:30 and 11:00 AM.

Step 4: Overlay the angle estimator as above to find what your angle is. Our azimuth angle is 20 degrees. We would orient our collector 20 degrees east of south.

Step 5: To determine the collector's tilt, divide the azimuth angle by five and add this to your latitude plus 15 degrees. In our example, $20/5 = 4$. If our latitude is 39 degrees, add 15 plus the additional 4 degrees to get a collector tilt of 58 degrees.

ESTIMATING ROOFTOP OR POLE-MOUNT COLLECTOR SHADING ON THE FUTURE HOME

Solar site analysis can be difficult when trying to estimate how much sunlight will strike the walls or roof of a building that hasn't been put up yet. Usually the future rooftop will likely be less shaded than the building site at the ground level. The following diagram and formula, with the use of the clear angle estimator, will give an estimated calculation of shading. <http://www.solarpathfinder.com/formulas>

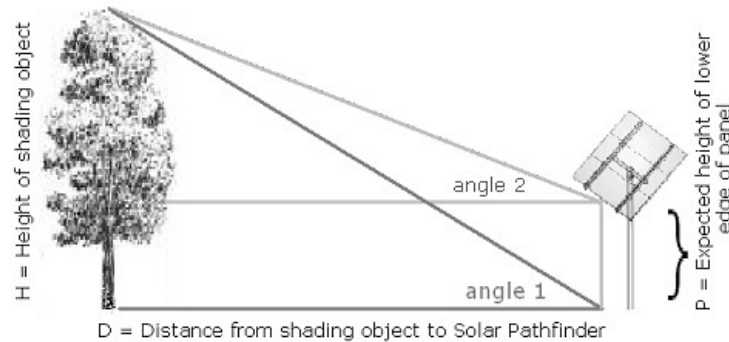

1. Place the Solar Pathfinder (SPF) on the ground in the location of the future PV panel. Using the grease pen supplied, trace around the shading objects directly onto the clear plastic angle estimator (also supplied with the SPF). The SPF clear angle estimator is write-on/wipe-off.
2. Use the clear angle estimator in the SPF at ground level to get the altitude (Angle 1) of the object shading the spot. [The altitude is the angle above the horizon - shown as concentric circles on the angle estimator.]
3. Using the values as described in the picture above, solve the following equation:

$$a2 = \tan^{-1} \left[\tan(a1) - \frac{P}{D} \right]$$

4. Plot the angle 2 (a^2) on the clear angle estimator along the same azimuth that angle 1 (a^1) was at. [The azimuth is the angle east or west of due south - shown as rays from the center of the angle estimator.] **NOTE: Any new angle 2 measurements that are negative indicate that the object will then be below the new heights' horizon and will cause no shading.**
5. You will need to repeat steps 2, 3, & 4 for each shading object (different shading objects will be located at different distances from the Pathfinder) in question.
6. Place the clear angle estimator with its new angle 2 measurements for the given height (H) on top of your latitude-specific sunpath diagram to see if the shading estimated at the new height will intersect the sunpath at your location (latitude).

For further explanation in a .pdf and an Excel spreadsheet to help calculate:

<http://www.solarpathfinder.com/formulas>

SEASONAL VARIATIONS IN FOLIAGE AND GROUND COVER

Thumb rules:

1. Do not count any half-hour periods shaded by evergreen trees, as they cast shadows year-round.
2. Do not count half-hour periods shaded by deciduous trees during the leaf-bearing months; **for thermal collectors, count these half-hour periods at half their value during non-leaf-bearing months. For PV panels, these half-hour periods should be assigned a value of zero, unless the manufacturer can support a better figure.**
3. Snow cover should cause an increase in the amount of solar radiation that a sloped collector receives due to reflection. This increase depends on the latitude, the collector tilt, and the kind of snow (new powder is best, decreasing as snow becomes old and icy). The average increase of solar radiation used for passive solar heating due to snow cover is only around five percent, but PV panels on a powder-snow-covered, clear, cold winter day often produce more watts than on the much longer sunny summer days.

FORMULAS

Detailed instructions for these formulas and Excel spreadsheets are available on our site:
<http://www.solarpathfinder.com/formulas>

To estimate shading of a rooftop/pole mount (not yet built):

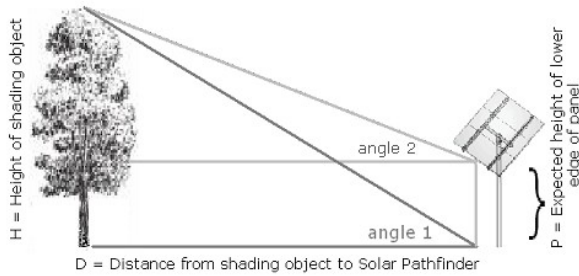

$$a2 = \text{Tan}^{-1} \left[\text{Tan}(a1) - \frac{P}{D} \right]$$

To estimate needed height (pole mount) to overcome shading:

Use the same values as seen in the picture above. Angle 2 is the altitude needed to clear the sun's path (place clear angle estimator over sun path diagram to determine desired altitude).

$$P = D[\tan(\text{angle}1) - \tan(\text{angle}2)]$$

To estimate amount of tree to be cropped to allow sunlight (for landscaping, golf course management, etc.):

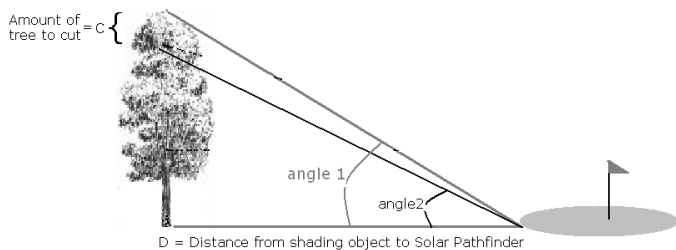

$$C = D[\tan(\text{angle}1) - \tan(\text{angle}2)]$$

INSTRUMENT CARE

The Solar Pathfinder™ has been built for years of professional use. However, the polycarbonate dome is easy to scratch. Be sure to store the dome assembly in the plastic bag it came in to protect it. If the dome needs cleaning, wipe it with a cotton ball soaked in rubbing alcohol, and blow on it to dry it. Wiping it with even a tissue or paper towel may scratch it!

Don't leave the Pathfinder™ inside a closed-up car or in a hot car trunk, as high temperatures may cause the dome to warp, as well as causing the compass or level vial to leak. Intense sub-freezing temperatures may also cause damage to the compass or level.

Replacement parts and extra diagrams are available from the Solar Pathfinder™ website store. Detailed instructions for various repairs are also on our site at: <http://www.solarpathfinder.com/repairs>

RESOURCES

For those who want to learn more about renewable energy, **Solar Energy International** (formerly Solar Technology Institute) offers several one and two-week workshops each year, many with hand-on experience. Contact them at PO Box 715, Carbondale, CO 81623. Phone: 970-963-8855. Web Site: <http://www.solarenergy.org/>

Home Power Magazine is at the center of the grass-roots renewable energy movement, with articles on every aspect of renewables, and lots of information and instructions on how to do it. Contact them at PO Box 520, Ashland, OR 97520. Phone: 800-707-6585 or 541-512-0201. Web Site: <http://www.homepower.com/>

Web site for US NREL Solar Radiation Data:
<http://rredc.nrel.gov/solar/pubs/redbook/>

WARRANTY

The Solar Pathfinder™ is guaranteed against defects in parts and workmanship, when used as directed for a period of 60 days from date of purchase.

If for some reason you are not completely satisfied with your new Solar Pathfinder™, we would like the opportunity to work with you to resolve your issues and ensure that your experience with Solar Pathfinder™ leaves you satisfied. If for you are still not satisfied with the Solar Pathfinder™, you may return it up to 15 days from date of receipt. In the event that you still wish to return your Solar Pathfinder™, here are a few things you should know:

- You are responsible for shipping the Solar Pathfinder™ back to us and for the costs associated with that shipment (We recommend that you insure your shipment.).
- It is important that you return everything on your order, and that it is in its original condition and packaging.

- We will credit your account for the Solar Pathfinder™ upon receipt.

LIMITATION OF LIABILITY

When used as directed, the Solar Pathfinder™ is an accurate, useful instrument for shade analysis. The Solar Pathfinder™ Assistant is the companion software designed to make use of the Solar Pathfinder™ easier and more efficient. However, Solar Pathfinder™ cannot be held liable for errors in use, or in the interpretation of site data, or for incorrectly sited collectors, photovoltaic panels, or buildings. Nor shall Solar Pathfinder™ be liable for any special, incidental, indirect, physical, economic or consequential damages whatsoever (including, without limitation, damages for loss of business profits, business interruption, loss of goodwill, or any other pecuniary loss) arising out of the use of or inability to use the Solar Pathfinder™ or the Solar Pathfinder™ Assistant.



Solar Pathfinder ASSISTANT™

RAISING THE STANDARD IN SOLAR SITE ANALYSIS

Try our new user-friendly companion software.
See our website for more details. Here is a sample report:

Serephim Energy
Solar Site Analysis Report

Image File 37-43 back yard 1.JPG

Solar Obstruction Data

Month	PVWatts Unshaded	% Actual Site	Actual Solar Rad w/o Shading	Actual Solar Rad w/ Shading	Actual AC Power (KWH) w/o shading	Actual AC Power (KWH) w/ shading	Actual Solar Savings
			KWH/m ² /day	KWH/m ² /day	AC Power (KWH)	AC Power (KWH)	
January	88.00%	2.58	1.86	1.64	36.00	31.88	1.59
February	95.00%	3.31	4.13	3.23	46.00	44.60	2.23
March	98.00%	4.13	5.18	4.07	62.00	61.00	3.05
April	99.00%	5.42	5.42	5.06	74.00	74.00	3.70
May	98.00%	5.01	5.34	5.29	96.00	94.66	4.73
June	98.00%	3.93	5.01	5.23	92.00	91.05	4.55
July	98.00%	2.95	4.90	4.90	94.00	92.83	4.64
August	98.00%	1.82	3.85	3.85	88.00	87.40	4.37
September	97.00%	2.85	2.85	1.65	67.00	66.40	3.32
October	97.00%	1.36	1.36	1.08	52.00	51.70	2.59
November	80.00%	1.36	1.36	1.08	32.00	29.46	1.47
December	80.00%	1.36	1.36	1.08	24.00	19.19	0.96
Totals	94.63%	Unweighted	Effect: 77.36%	Effect: 74.51%	763.0	744.17	\$37.21
		Yearly Avg	Sun Hrs: 3.57	Sun Hrs: 3.44			

Report Name: Casey, John 1001

Report Date: 1/18/2008 10:41:00

Declination: -4d 3m

Location: FRANKLIN, IN

Lat/Long: 39.469 / -86.06

Weather Station: INDIANAPOLIS

Site distance: 21.56 miles

Array Type: Fixed

Tilt Angle: 45.00 degrees

Ideal Tilt Angle: 39.47 degrees

Electrical Cost: 5.00

Azimuth: 270.00

Ideal Azimuth: 180.00

Panel Make: Kyocera

Panel Model: KC

Panel Count: 1

DC Rate (per panel): 1

Inverter Make: 1

Inverter Model: 1

Inverter Count: 1

Derate Method: 1

Derate Factor: 1

Layout Configuration: 1

Layout Point Count: 1

Notes:

WA #SERAPEC971MG

Report generated by SolarPathfinder Assistant Version 3.0.1.0.

Page: 2/2

987.654.3210

<http://www.solarpathfinder.com>